

Product Summary

The GESDB5V0D51S is designed to protect voltage sensitive electronic components from ESD and other transients. Excellent clamping capability, low leakage, low capacitance, and fast response time provide best in class protection on designs that are exposed to ESD.

The combination of small size, low capacitance, and high level of ESD protection makes them a flexible solution for applications such as HDMI, Display Port TM, and MDDI interfaces. It is designed to replace multiplayer varistors (MLV) in consumer

Feature

- Low reverse stand-off voltage: 5V Max.
- Low capacitance: 3pF(Typ.)
- Low leakage current
- Fast response time
- ESD Rating of Class 3(>16kV) Per Human Body Model
- IEC 61000-4-2 Level 4 ESD protection

Application

- Computers and peripherals
- Portable electronics
- High speed data lines
- Audio and video equipment
- Cellular handsets and accessories
- Other electronic equipment communication systems

Marking:



Front Side
HD=Device Code

SOD-523

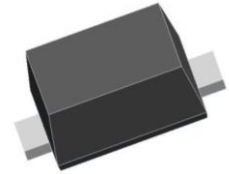

Schematic diagram

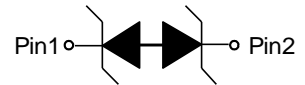

Absolute Maximum Ratings ($T_a=25^{\circ}\text{C}$ unless otherwise noted)

Parameter	Symbol	Value	Unit
IEC 61000-4-2 ESD Voltage	Air Model	± 15	kV
IEC 61000-4-2 ESD Voltage	Contact Model	± 15	
ESD Voltage	Per Human Body Model	± 16	
ESD Voltage	Machine Model	± 0.4	
Peak Pulse Power	$P_{PP}^{2)}$	45	W
Peak Pulse Current	$I_{PP}^{2)}$	3	A
Lead Solder Temperature – Maximum (10 Second Duration)	T_L	260	$^{\circ}\text{C}$
Junction Temperature	T_j	150	$^{\circ}\text{C}$
Storage Temperature	T_{stg}	-55~ +150	$^{\circ}\text{C}$

- 1) Device stressed with ten non-repetitive ESD pulses.
- 2) Non-repetitive current pulse 8/20 μs exponential decay waveform according to IEC61000-4-5.

ESD standards compliance

IEC61000-4-2 Standard

Contact Discharge		Air Discharge	
Level	Test Voltage kV	Level	Test Voltage kV
1	2	1	2
2	4	2	4
3	6	3	8
4	8	4	15

JESD22-A114-B Standard

ESD Class	Human Body Discharge V
0	0~249
1A	250~499
1B	500~999
1C	1000~1999
2	2000~3999
3A	4000~7999
3B	8000~15999

Contact discharge current waveform per IEC61000-4-2

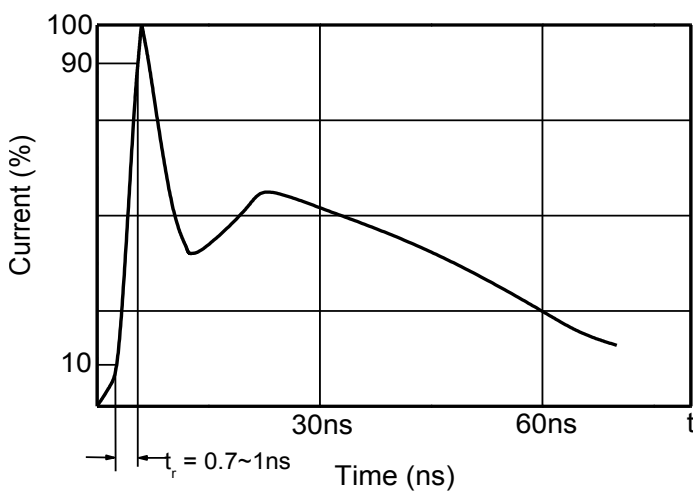

8/20 μs waveform per IEC61000-4-5

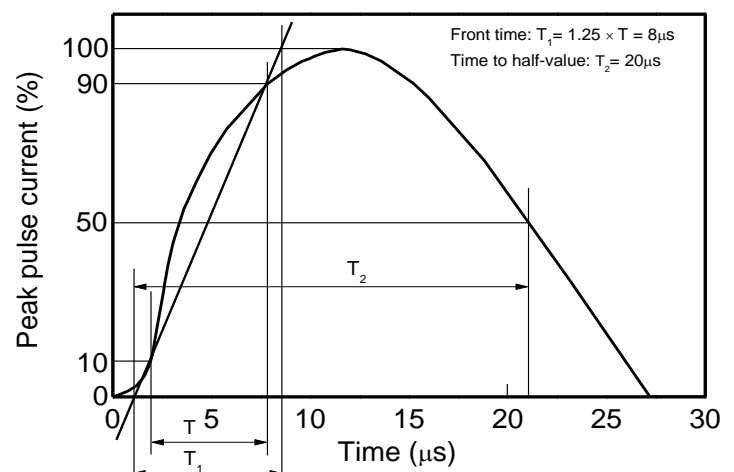

Electrical Parameter

Symbol	Parameter
V _C	Clamping Voltage @ I _{PP}
I _{PP}	Peak Pulse Current
V _{BR}	Breakdown Voltage @ I _{BR}
I _{BR}	Test Current
I _R	Reverse Leakage Current @ V _{RWM}
V _{RWM}	Reverse Standoff Voltage

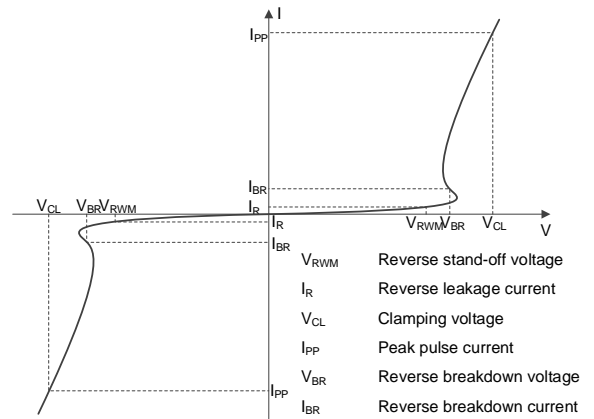

V-I characteristics for a Bi-directional TVS

Electrical Characteristics (T_a=25°C unless otherwise specified)

Parameter	Symbol	Test conditions	Min	Typ	Max	Unit
Reverse standoff voltage	V _{RWM}				5	V
Reverse leakage current	I _R	V _{RWM} =5V			1	μA
Breakdown voltage	V _{BR} ¹⁾	I _T =1mA	5.6		9	V
Clamping voltage	V _{C1}	I _{PP} =1A		9	11	V
	V _{C2}	I _{PP} =2A		12	15	V
Junction capacitance	C _J	V _R =0V, f=1MHz		3		pF

1) V_{BR} is measured with a pulse test current I_T at an ambient temperature of 25°C

Typical Characteristics

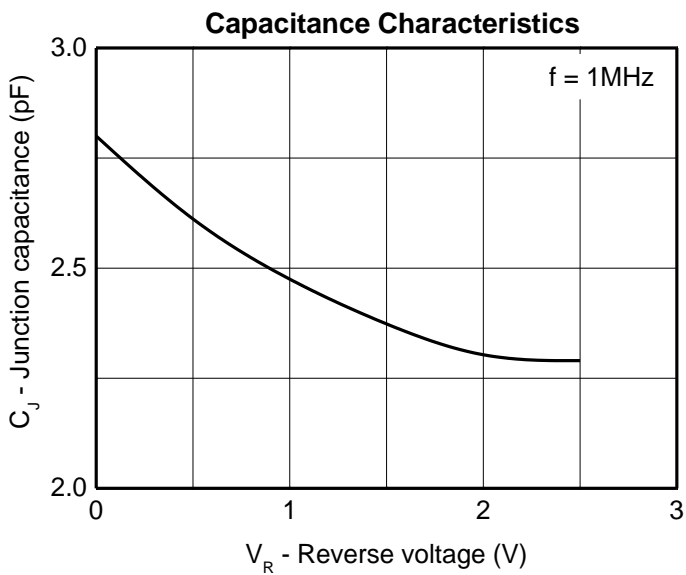
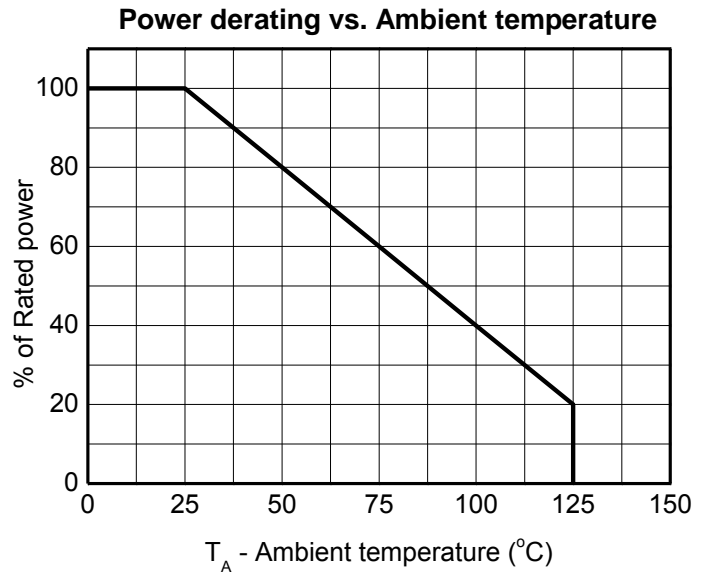
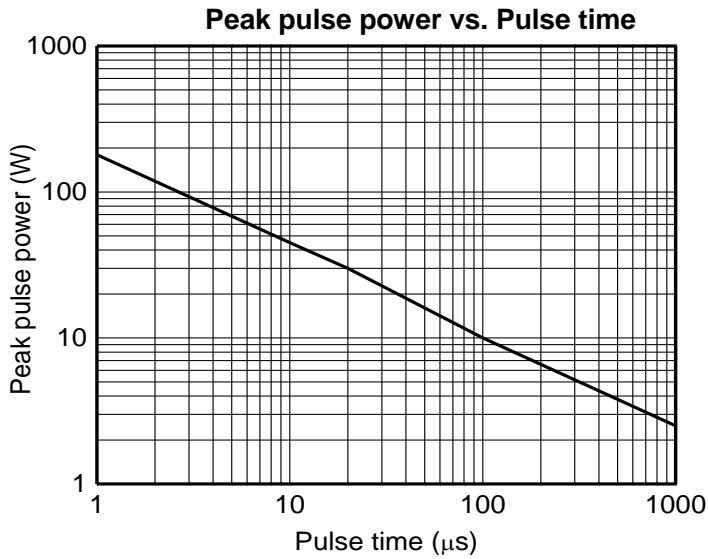
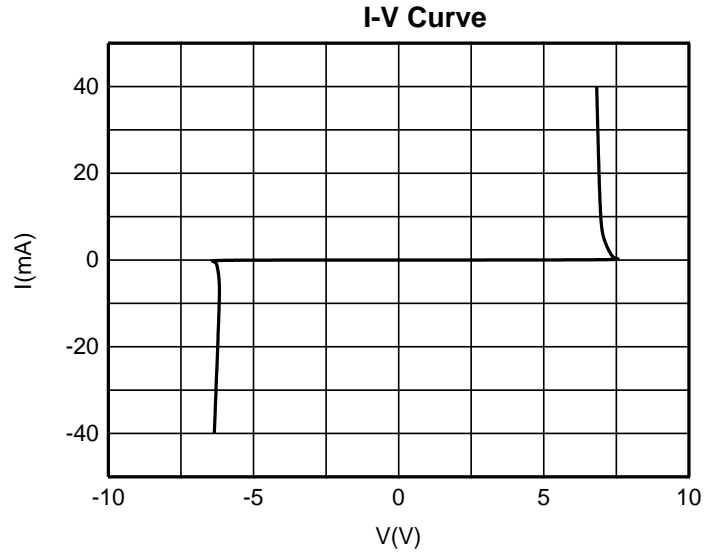
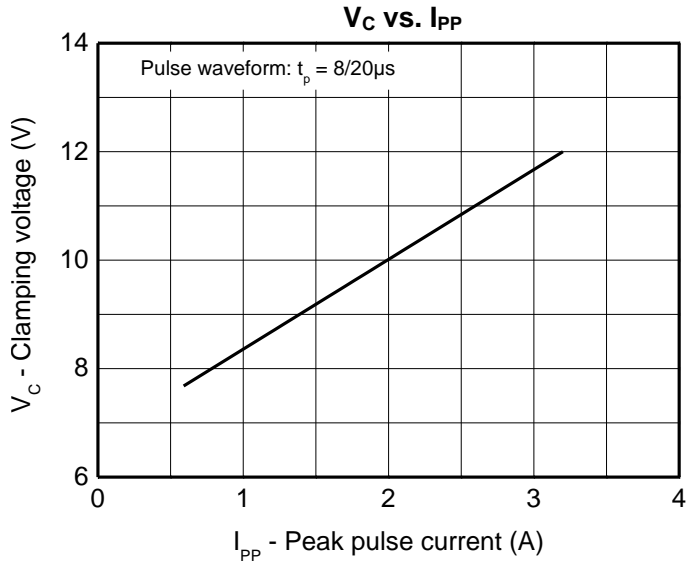

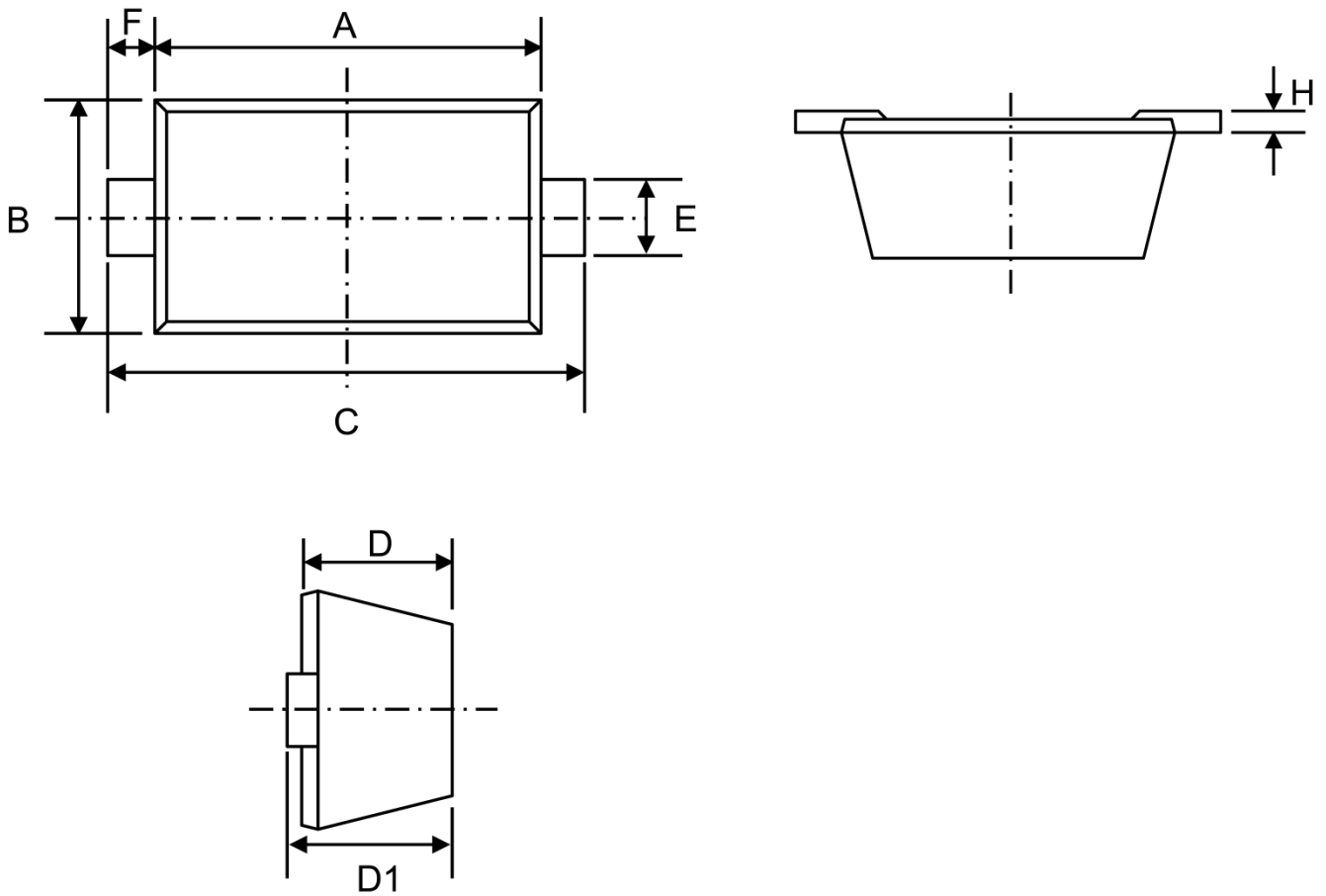
SOD-523 Package Outline Dimension

	Dimensions In Millimeters	
	Min.	Max.
A	1.10	1.30
B	0.70	0.90
C	1.50	1.70
D	0.50	0.70
D1	0.51	0.77
E	0.25	0.35
F	0.20REF	
H	0.07	0.20