

Product Summary

The GESDBK3V3D51P is designed to protect voltage sensitive electronic components from ESD and other transients. Excellent clamping capability, low leakage, low capacitance, and fast response time, make these parts ideal for ESD protection on designs where board space is at a premium. Because of its small size, it is suited for use in digital cameras, cellular phones, MP3 players and many other portable applications where board space is at a premium.

Feature

- Low reverse stand-off voltage: 3.3V
- Low reverse clamping voltage
- Low leakage current
- Fast response time
- JESD22-A114-B ESD Rating of class 3B per human body model
- IEC 61000-4-2 Level 4 ESD protection

Application

- Computers and peripherals
- Portable electronics
- Power lines
- Audio and video equipment
- Cellular handsets and accessories
- Other electronic equipment communication systems

Marking:



Front Side
LB =Device Code

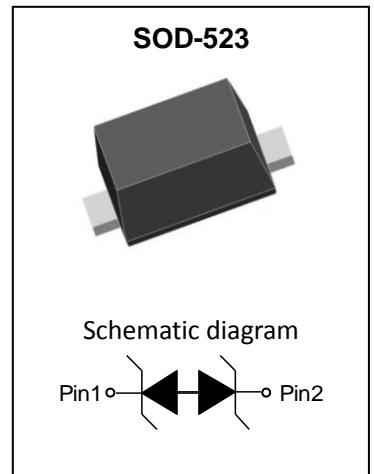

Absolute Maximum Ratings ($T_a=25^{\circ}\text{C}$ unless otherwise noted)

Parameter	Symbol	Value	Unit
IEC 61000-4-2 ESD Voltage Air Model	$V_{\text{ESD}}^{1)}$	± 20	kV
IEC 61000-4-2 ESD Voltage Contact Model		± 20	
JESD22-A114-B ESD Voltage Per Human Body Model		± 16	
ESD Voltage Machine Model		± 0.4	
Peak Pulse Power	$P_{\text{PP}}^{2)}$	40	W
Peak Pulse Current	$I_{\text{PP}}^{2)}$	3.5	A
Lead Solder Temperature – Maximum (10 Second Duration)	T_L	260	$^{\circ}\text{C}$
Junction Temperature	T_j	150	$^{\circ}\text{C}$
Storage Temperature	T_{stg}	-55~ +150	$^{\circ}\text{C}$

- 1) Device stressed with ten non-repetitive ESD pulses.
- 2) Non-repetitive current pulse 8/20 μs exponential decay waveform according to IEC61000-4-5.

ESD standards compliance

IEC61000-4-2 Standard

Contact Discharge		Air Discharge	
Level	Test Voltage kV	Level	Test Voltage kV
1	2	1	2
2	4	2	4
3	6	3	8
4	8	4	15

JESD22-A114-B Standard

ESD Class	Human Body Discharge V
0	0~249
1A	250~499
1B	500~999
1C	1000~1999
2	2000~3999
3A	4000~7999
3B	8000~15999

Contact discharge current waveform per IEC61000-4-2

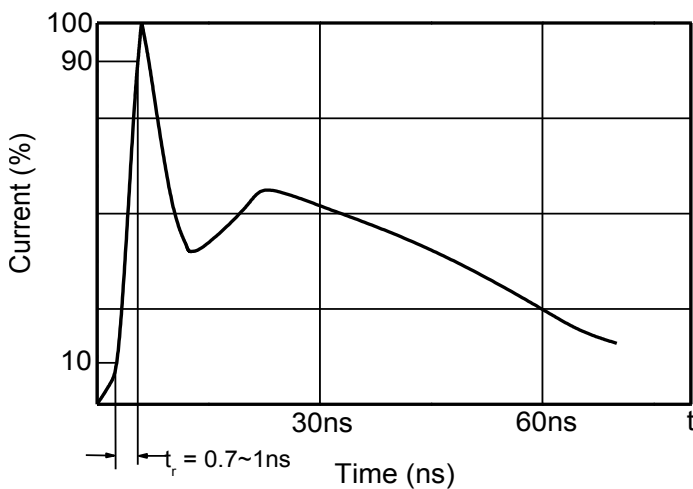

8/20 μs waveform per IEC61000-4-5

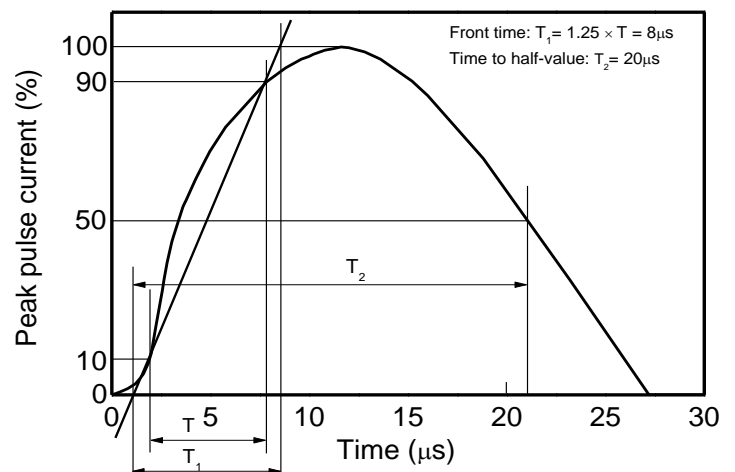

Electrical Parameter

Symbol	Parameter
V _C	Clamping Voltage @ I _{PP}
I _{PP}	Peak Pulse Current
V _{BR}	Breakdown Voltage @ I _{BR}
I _{BR}	Test Current
I _R	Reverse Leakage Current @ V _{RWM}
V _{RWM}	Reverse Standoff Voltage

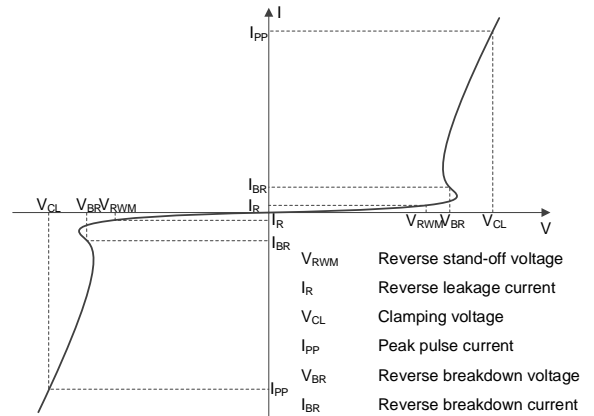

V-I characteristics for a Bi-directional TVS

Electrical Characteristics (Ta=25°C unless otherwise specified)

Parameter	Symbol	Test conditions	Min	Typ	Max	Unit
Reverse stand-off voltage	V _{RWM} ¹⁾				3.3	V
Reverse leakage current	I _R	V _{RWM} =3.3V			1	uA
Breakdown voltage	V _{BR}	I _T =1mA	5			V
Clamping voltage	V _C ²⁾	I _{PP} =3.5A		11		V
Junction capacitance	C _J	V _R =0V, f=1MHz		5		pF

1) Other voltages available upon request.

2) Non-repetitive current pulse 8/20μs exponential decay waveform according to IEC61000-4-5

Typical Characteristics

V_C vs. I_{PP}

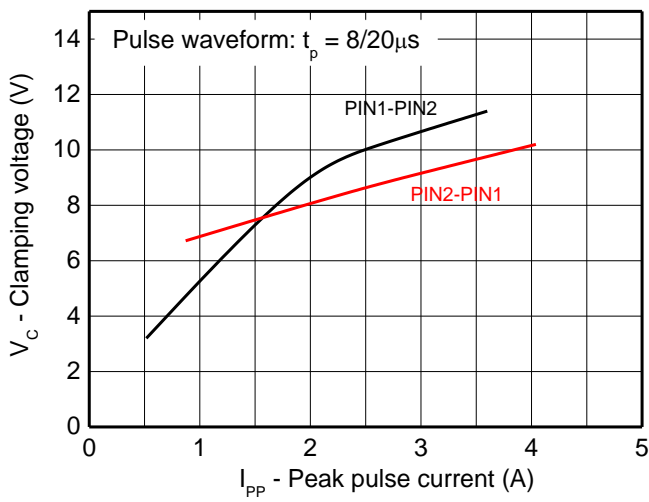

I-V Curve

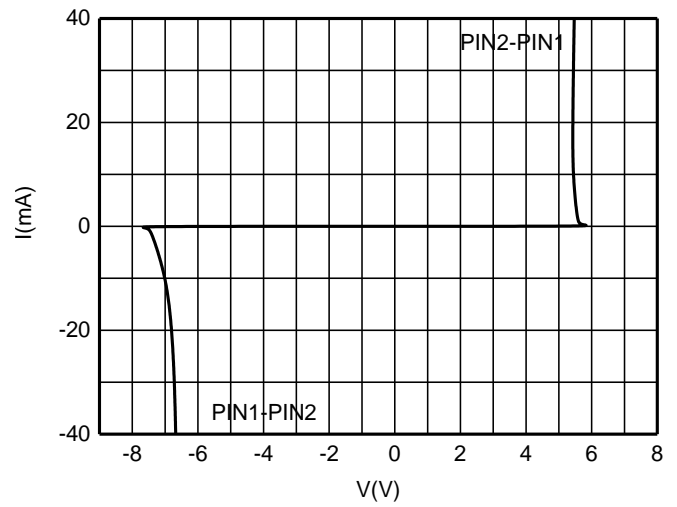

Peak pulse power vs. Pulse time

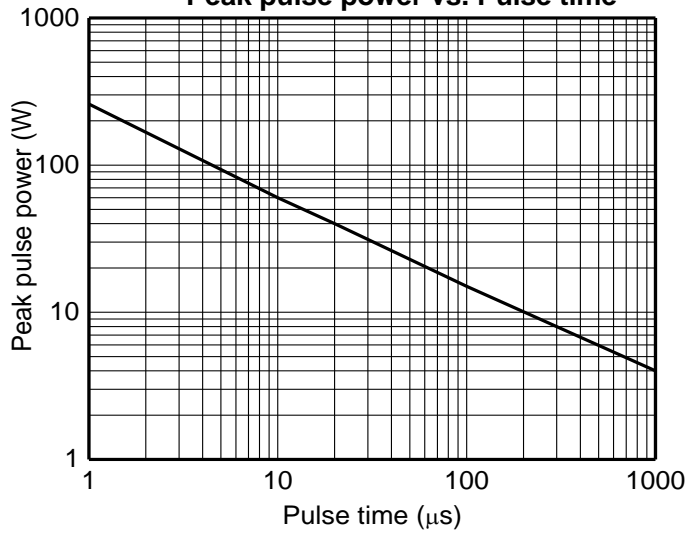

Power derating vs. Ambient temperature

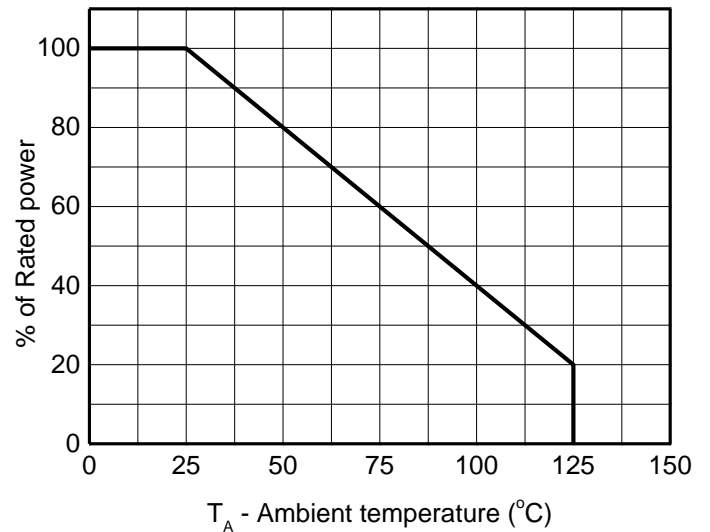

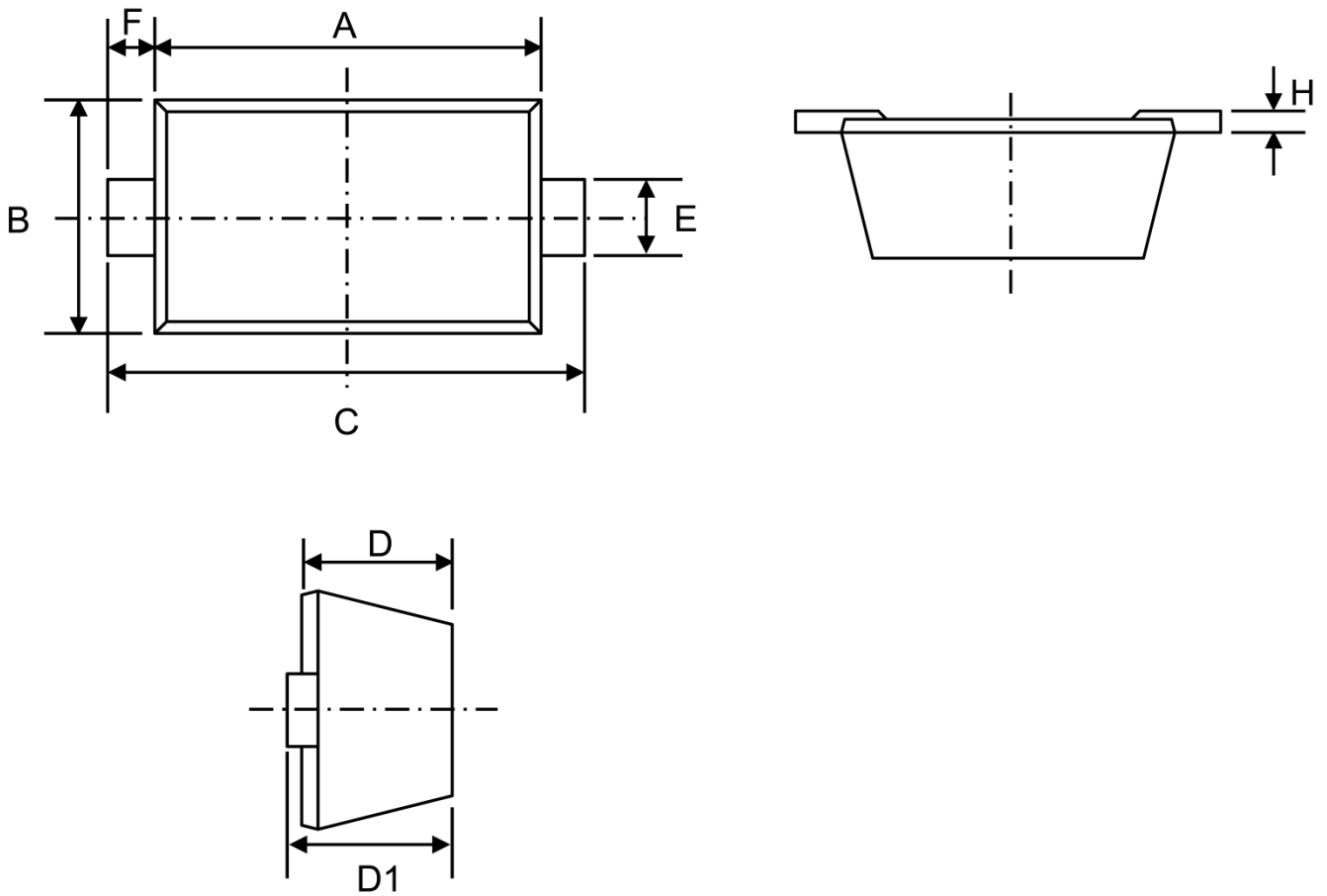
SOD-523 Package Outline Dimension

	Dimensions In Millimeters	
	Min.	Max.
A	1.10	1.30
B	0.70	0.90
C	1.50	1.70
D	0.50	0.70
D1	0.51	0.77
E	0.25	0.35
F	0.20REF	
H	0.07	0.20