



DTC143TM Digital Transistor(NPN)

Feature

- Built-in bias resistors enable the configuration of an inverter circuit without connecting external input resistors
- The bias resistors consist of thin-film resistors with complete isolation to allow positive biasing of the input .They also have the advantage of almost completely eliminating parasitic effects
- Only the on/off conditions need to be set for operation, making device design easy

Schematic Circuit

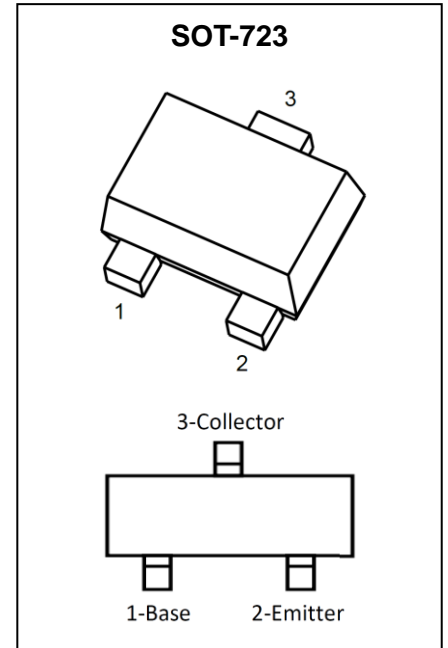
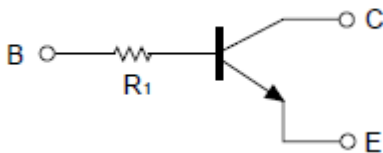

ABSOLUTE MAXIMUM RATINGS ($T_a=25^{\circ}\text{C}$ unless otherwise noted)

Parameter	Symbol	Value	Unit
Collector-base Voltage	V_{CBO}	50	V
Collector-emitter Voltage	V_{CEO}	50	V
Collector current	I_C	100	mA
Power Dissipation	P_D	100	mW
Junction Temperature	T_J	125	$^{\circ}\text{C}$
Storage Temperature Range	T_{STG}	-45 ~ +125	$^{\circ}\text{C}$

ELECTRICAL CHARACTERISTICS ($T_a=25^{\circ}\text{C}$ unless otherwise noted)

Parameter	Symbol	Test Condition	Min	Type	Max	Unit
Collector-base breakdown voltage	BV_{CBO}	$I_C=50\mu\text{A}$	50			V
Collector-emitter breakdown	BV_{CEO}	$I_C=1\text{mA}$	50			V
Emitter-base breakdown voltage	BV_{EBO}	$I_E=50\mu\text{A}$	5			V
Collector cutoff current	I_{CBO}	$V_{CB}=50\text{V}$			0.5	μA
Emitter cutoff current	I_{EBO}	$V_{EB}=4\text{V}$			0.5	μA
Collector-emitter saturation	$V_{CE(SAT)}$	$I_C=5\text{mA}, I_B=0.25\text{mA}$			0.3	V
DC current transfer ratio	h_{FE}	$I_C=1\text{mA}, V_{CE}=5\text{V}$	100		600	
Input resistance	R_1		3.29	4.7	6.11	k Ω
Transition frequency	f_T	$V_{CE}=10\text{V}, I_E=5\text{mA}, f=1\text{MHz}$		250		MHz

Typical Characteristics

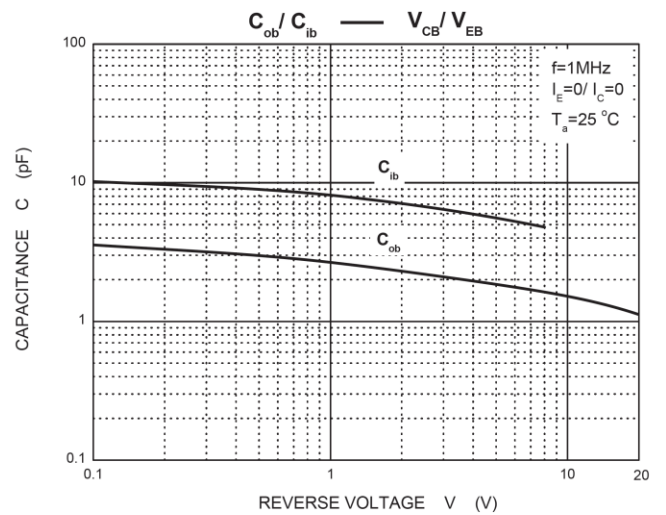
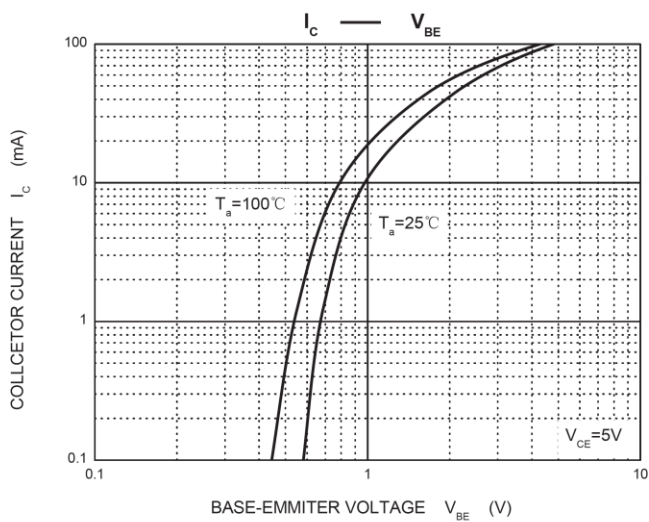
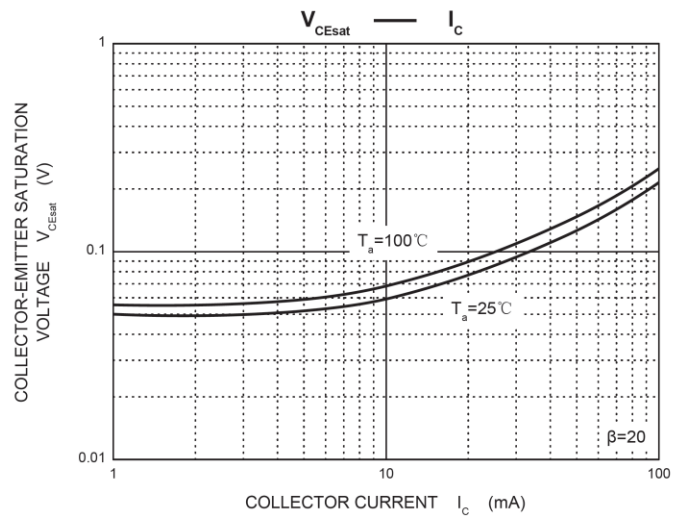
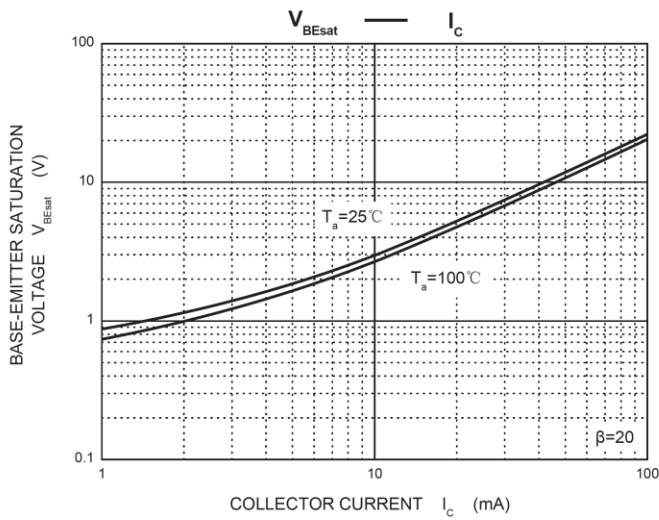
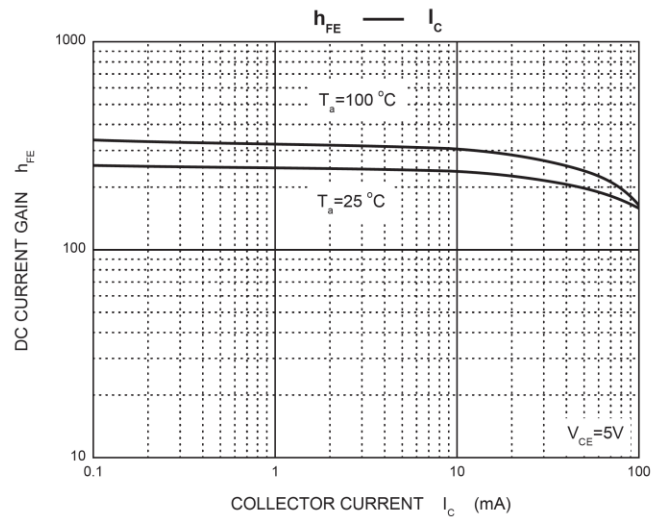
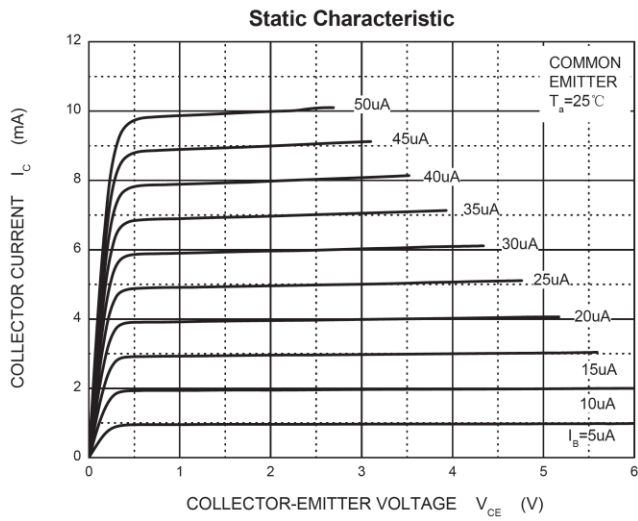

SOT-723 Package Information

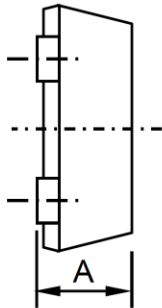
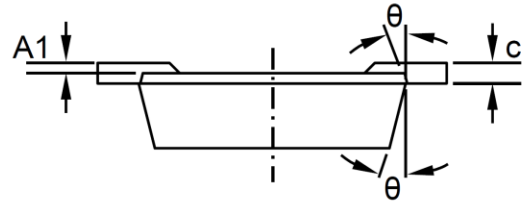
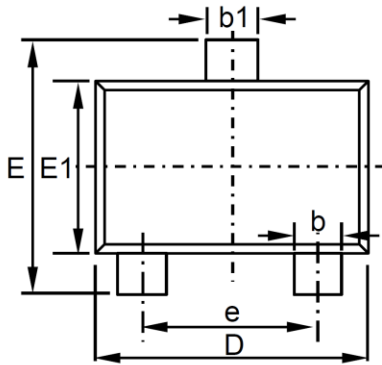

SOT-723 (unit: mm)		
Dim.	Min.	Max.
A	0.40	0.50
A1	0.00	0.05
b	0.15	0.27
b1	0.20	0.37
c	0.06	0.16
D	1.10	1.30
E	1.10	1.30
E1	0.70	0.90
e	0.80 TYP.	
θ	7° REF.	