



DTC144EM Digital Transistor(NPN)

Feature

- Built-in bias resistors enable the configuration of an inverter circuit without connecting external input resistors
- The bias resistors consist of thin-film resistors with complete isolation to allow positive biasing of the input .They also have the advantage of almost completely eliminating parasitic effects
- Only the on/off conditions need to be set for operation, making device design easy

Schematic diagram

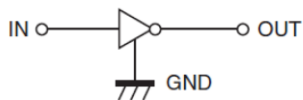
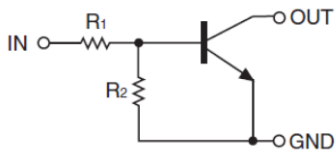

Marking: 26

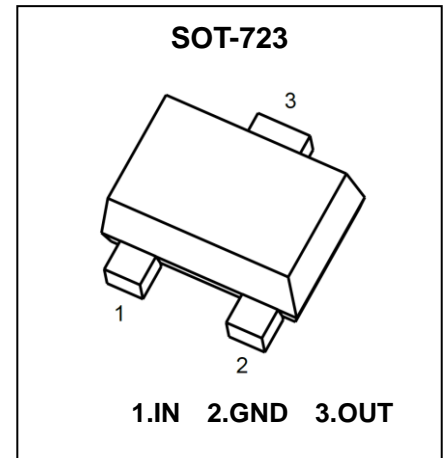

ABSOLUTE MAXIMUM RATINGS ($T_a=25^{\circ}\text{C}$ unless otherwise noted)

Parameter	Symbol	Value	Unit
Supply Voltage	V_{CC}	50	V
Input Voltage	V_{IN}	-10~+40	V
Output Current	I_o	100	mA
Power Dissipation	P_D	150	mW
Junction Temperature	T_J	125	$^{\circ}\text{C}$
Storage Temperature Range	T_{STG}	-45 ~ +125	$^{\circ}\text{C}$

ELECTRICAL CHARACTERISTICS ($T_a=25^{\circ}\text{C}$ unless otherwise noted)

Parameter	Symbol	Test Condition	Min	Type	Max	Unit
Input voltage	$V_{I(off)}$	$V_{CC}=5V, I_o=100\mu A$	0.5			V
	$V_{I(on)}$	$V_o=0.3V, I_o=10mA$			3	V
Output voltage	$V_{O(on)}$	$I_o=10mA, I_i=0.5mA$			0.3	V
Input current	I_i	$V_i=5V$			0.88	mA
Output current	$I_{O(off)}$	$V_{CC}=50V, V_i=0V$			0.5	μA
DC current gain	G_i	$V_o=5V, I_o=5mA$	30			
Input resistance	R_1		32.9	47	61.1	k Ω
Resistance ratio	R_2/R_1		0.8	1	1.2	
Transition frequency	f_T	$V_o=10V, I_o=5mA, f=1MHz$		250		MHz

Typical Characteristics

ON Characteristics

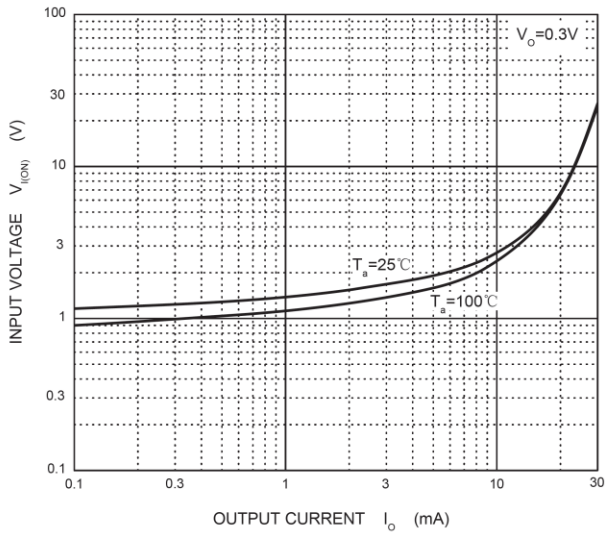

OFF Characteristics

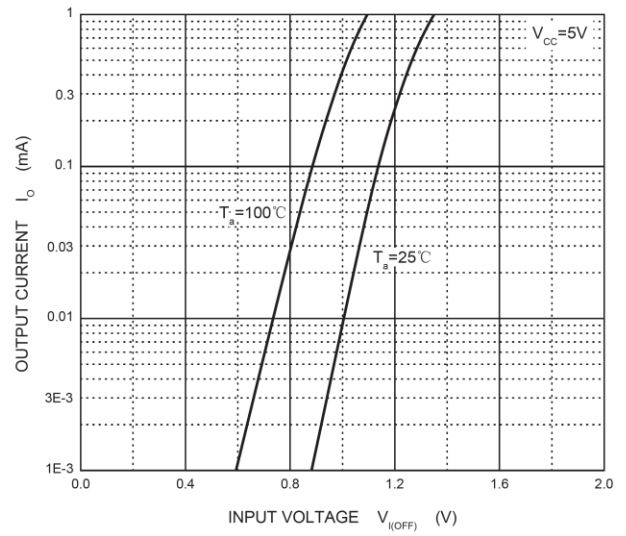

$V_{o(ON)}$ — I_o

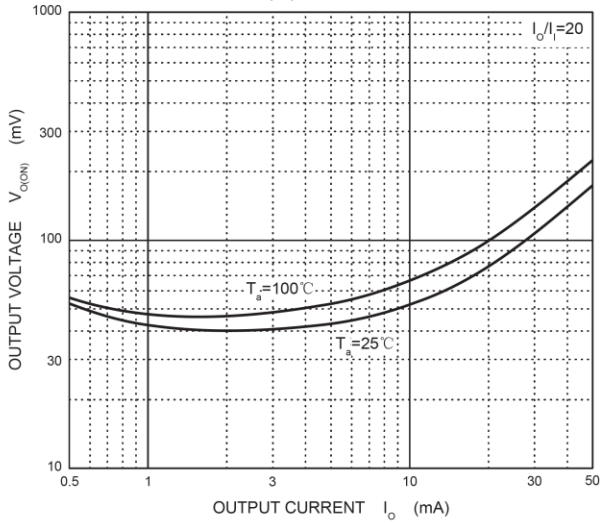

G_1 — I_o

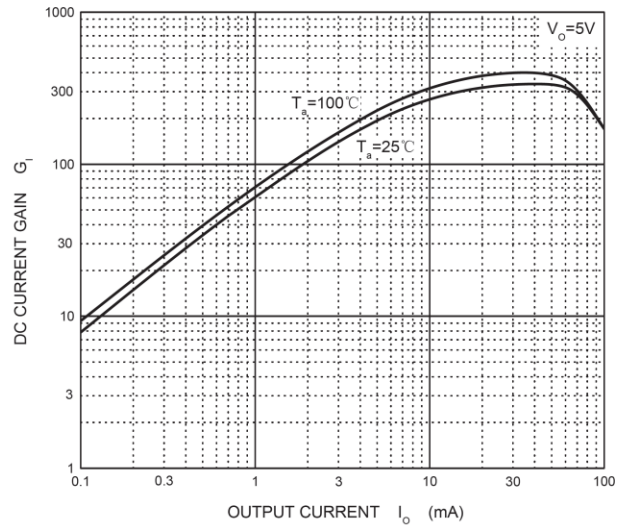

SOT-723 Package Information

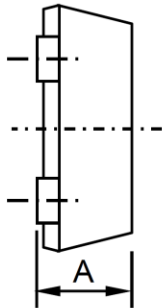
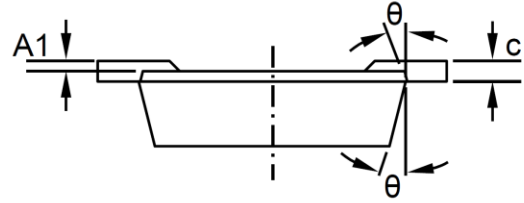
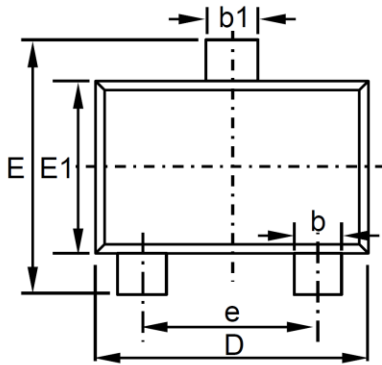

SOT-723 (unit: mm)		
Dim.	Min.	Max.
A	0.40	0.50
A1	0.00	0.05
b	0.15	0.27
b1	0.20	0.37
c	0.06	0.16
D	1.10	1.30
E	1.10	1.30
E1	0.70	0.90
e	0.80 TYP.	
θ	7° REF.	