

Product Summary

$V_{(BR)DSS}$	$R_{DS(on)TYP}$	I_D
100V	3mΩ@10V	145A

Feature

- Split Gate Trench Technology
- Low $R_{DS(ON)}$
- Low Gate Charge
- Low Gate Resistance
- 100% UIS Tested

Application

- Power Switching Application

MARKING:

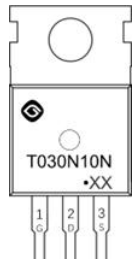

T030N03N = Device Code
 XX = Date Code
 Solid Dot = Green Indicator

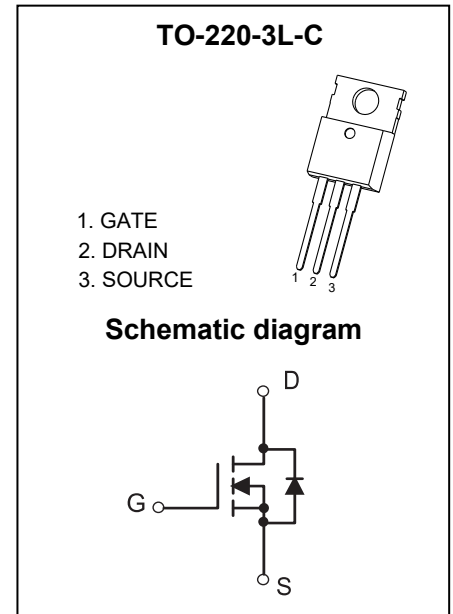

ABSOLUTE MAXIMUM RATINGS ($T_A = 25^\circ\text{C}$ unless otherwise noted)

Parameter	Symbol	Value	Unit	
Drain - Source Voltage	V_{DS}	100	V	
Gate - Source Voltage	V_{GS}	±20	V	
Continuous Drain Current ¹	$T_C = 25^\circ\text{C}$	I_D	145	A
	$T_C = 100^\circ\text{C}$	I_D	102	A
Pulsed Drain Current ²	I_{DM}	580	A	
Single Pulsed Avalanche Current ³	I_{AS}	27	A	
Single Pulsed Avalanche Energy ³	E_{AS}	182	mJ	
Power Dissipation ⁵	$T_C = 25^\circ\text{C}$	P_D	417	W
Thermal Resistance from Junction to Ambient ⁶	$R_{\theta JA}$	60	$^\circ\text{C}/\text{W}$	
Thermal Resistance from Junction to Case	$R_{\theta JC}$	0.3	$^\circ\text{C}/\text{W}$	
Junction Temperature	T_J	150	$^\circ\text{C}$	
Storage Temperature	T_{STG}	-55~ +150	$^\circ\text{C}$	

MOSFET ELECTRICAL CHARACTERISTICS ($T_J = 25^\circ\text{C}$ unless otherwise noted)

Parameter	Symbol	Test Condition	Min	Type	Max	Unit
Off Characteristics						
Drain - Source Breakdown Voltage	$V_{(BR)DSS}$	$V_{GS} = 0V, I_D = 250\mu A$	100			V
Zero Gate Voltage Drain Current	I_{DSS}	$V_{DS} = 100V, V_{GS} = 0V$			1	μA
Gate - Body Leakage Current	I_{GSS}	$V_{GS} = \pm 20V, V_{DS} = 0V$			± 100	nA
On Characteristics⁴						
Gate Threshold Voltage	$V_{GS(th)}$	$V_{DS} = V_{GS}, I_D = 250\mu A$	2.0	2.9	4.0	V
Drain-source On-resistance	$R_{DS(on)}$	$V_{GS} = 10V, I_D = 20A$		3.0	3.9	m Ω
Forward Transconductance	g_{FS}	$V_{DS} = 5V, I_D = 20A$		50		S
Dynamic Characteristics						
Input Capacitance	C_{iss}	$V_{DS} = 50V, V_{GS} = 0V, f = 1MHz$		5673		pF
Output Capacitance	C_{oss}			1480		
Reverse Transfer Capacitance	C_{rss}			69		
Gate Resistance	R_g	$V_{DS} = 0V, V_{GS} = 0V, f = 1MHz$		2.9		Ω
Switching Characteristics						
Total Gate Charge	Q_g	$V_{DS} = 50V, V_{GS} = 10V, I_D = 20A$		80.9		nC
Gate-source Charge	Q_{gs}			25.3		
Gate-drain Charge	Q_{gd}			16.0		
Turn-on Delay Time	$t_{d(on)}$	$V_{DD} = 50V, V_{GS} = 10V, R_L = 2.5\Omega$ $R_G = 3\Omega$		31		ns
Turn-on Rise Time	t_r			22		
Turn-off Delay Time	$t_{d(off)}$			44		
Turn-off Fall Time	t_f			28		
Source - Drain Diode Characteristics						
Diode Forward Voltage ⁴	V_{SD}	$V_{GS} = 0V, I_S = 20A$			1.2	V

Notes :

- 1.The maximum current rating is limited by package.And device mounted on a large heatsink
- 2.Pulse Test : Pulse Width $\leq 10\mu s$, duty cycle $\leq 1\%$.
- 3.EAS condition: $V_{DD} = 50V, V_{GS} = 10V, L = 0.5mH, R_G = 25\Omega$ Starting $T_J = 25^\circ\text{C}$.
- 4.Pulse Test : Pulse Width $\leq 300\mu s$, duty cycle $\leq 2\%$.
- 5.The power dissipation P_D is limited by $T_{J(MAX)} = 150^\circ\text{C}$.And device mounted on a large heatsink
- 6.Device mounted on $1in^2$ FR-4 board with 2oz. Copper, in a still air environment with $T_A = 25^\circ\text{C}$.

Typical Characteristics

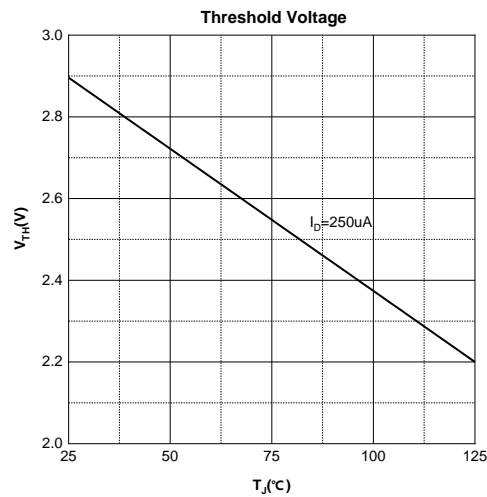
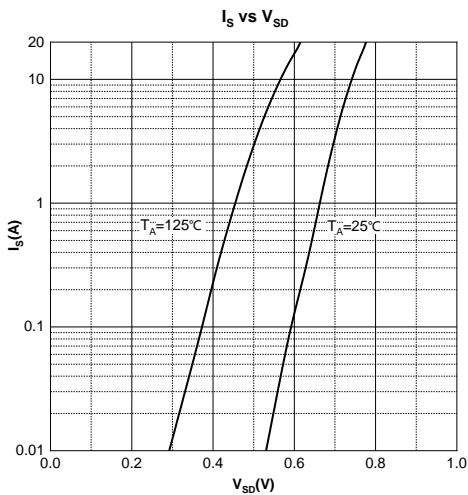
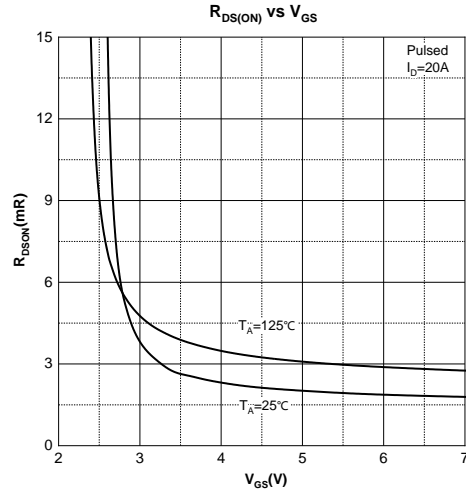
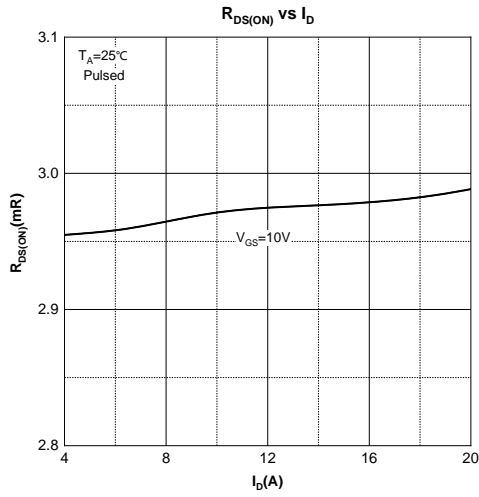
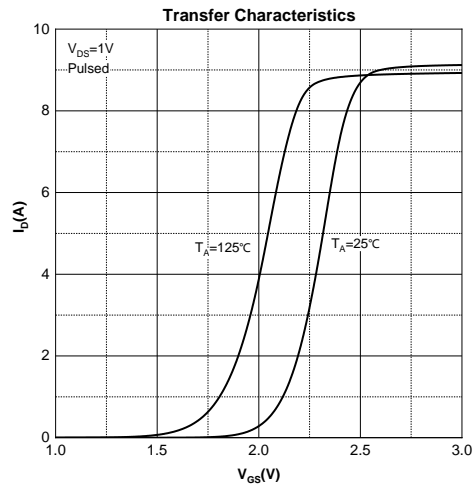
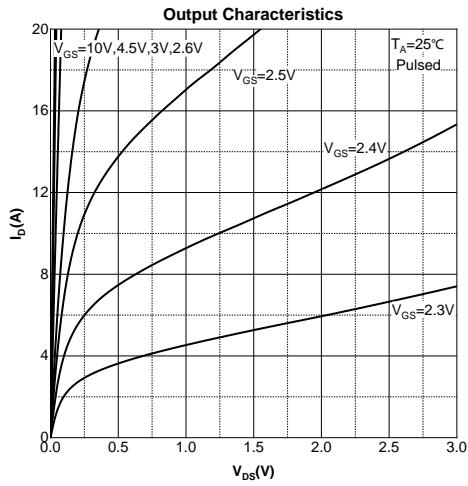

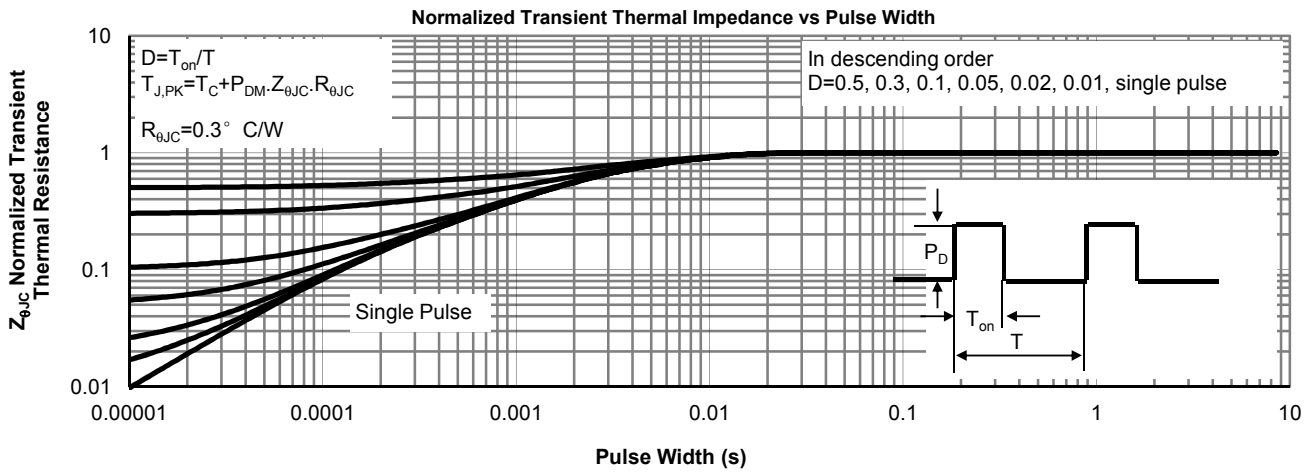
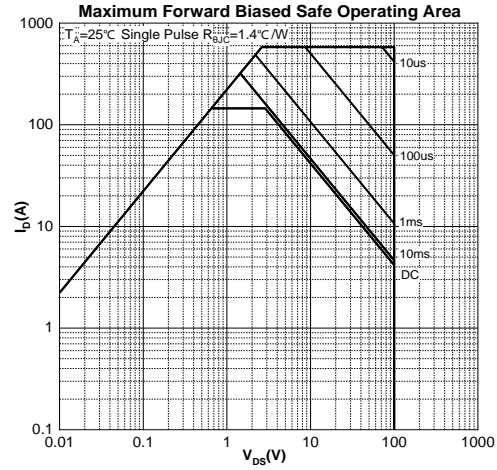
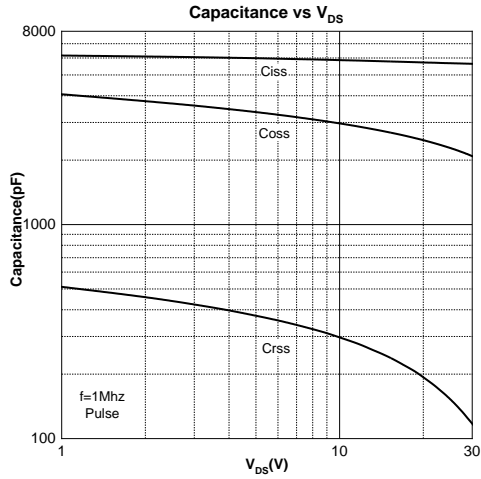

TO-220-3L-C Package Information

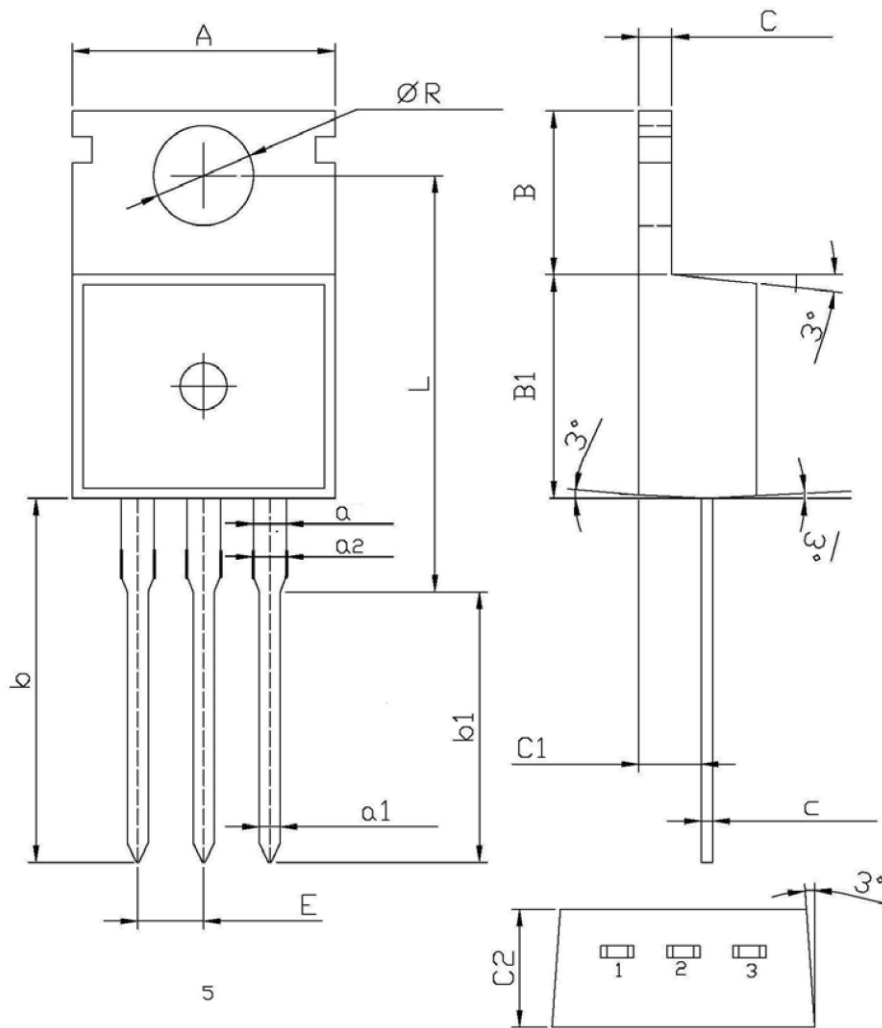

Symbol	Dimensions In Millimeters		Dimensions In Inches	
	Min.	Max.	Min.	Max.
A	9.800	10.200	0.386	0.402
R	3.560	3.640	0.140	0.143
L	15.700	16.100	0.618	0.634
b	12.600	13.600	0.496	0.535
b1	9.600	10.600	0.378	0.417
a	1.220	1.320	0.048	0.052
E	2.340	2.740	0.092	0.108
a2	1.250	1.450	0.049	0.057
C	1.200	1.400	0.047	0.055
B	6.300	6.700	0.248	0.264
B1	9.000	9.400	0.354	0.370
C1	2.200	2.600	0.087	0.102
a1	0.700	0.900	0.028	0.035
c	0.400	0.600	0.016	0.024
C2	4.300	4.700	0.169	0.185