



Product Summary

$V_{(BR)DSS}$	$R_{DS(on)TYP}$	I_D
650V	620m Ω @10V	12A

Feature

- Trench Technology Power MOSFET
- Low $R_{DS(ON)}$
- Low Gate Charge
- Low Gate Resistance
- 100% UIS Tested
- 100% ΔV_{DS} Tested

Application

- Power Switching Application

TO-220-3L-F



Schematic diagram

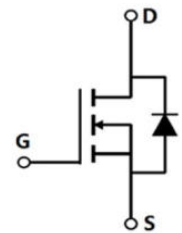

MARKING:



12N65= Device Code
XX = Date Code
Solid Dot = Green Indicator

ABSOLUTE MAXIMUM RATINGS ($T_A = 25^\circ\text{C}$ unless otherwise noted)

Parameter	Symbol	Value	Unit
Drain - Source Voltage	V_{DS}	650	V
Gate - Source Voltage	V_{GS}	± 30	V
Continuous Drain Current ¹	I_D	12	A
	$T_C = 25^\circ\text{C}$		
Pulsed Drain Current ²	I_{DM}	48	A
Single Pulsed Avalanche Current ³	I_{AS}	9	A
Single Pulsed Avalanche Energy ³	E_{AS}	20.2	mJ
Power Dissipation ⁵	P_D	50	W
	$T_C = 25^\circ\text{C}$		
Thermal Resistance from Junction to Ambient ⁶	$R_{\theta JA}$	65	$^\circ\text{C/W}$
Thermal Resistance from Junction to Case	$R_{\theta JC}$	2.5	$^\circ\text{C/W}$
Junction Temperature	T_J	150	$^\circ\text{C}$
Storage Temperature	T_{STG}	-55~ +150	$^\circ\text{C}$

MOSFET ELECTRICAL CHARACTERISTICS ($T_J = 25^\circ\text{C}$ unless otherwise noted)

Parameter	Symbol	Test Condition	Min	Type	Max	Unit
Off Characteristics						
Drain - Source Breakdown Voltage	$V_{(BR)DSS}$	$V_{GS} = 0V, I_D = 250\mu A$	650			V
Zero Gate Voltage Drain Current	I_{DSS}	$V_{DS} = 650V, V_{GS} = 0V$			1	μA
Gate - Body Leakage Current	I_{GSS}	$V_{GS} = \pm 30V, V_{DS} = 0V$			± 100	nA
On Characteristics⁴						
Gate Threshold Voltage	$V_{GS(th)}$	$V_{DS} = V_{GS}, I_D = 250\mu A$	2	3.2	4	V
Drain-source On-resistance	$R_{DS(on)}$	$V_{GS} = 10V, I_D = 1A$		620	800	m Ω
Dynamic Characteristics						
Input Capacitance	C_{iss}	$V_{DS} = 45V, V_{GS} = 0V, f = 1MHz$		2206		pF
Output Capacitance	C_{oss}			112.7		
Reverse Transfer Capacitance	C_{rss}			1.6		
Gate Resistance	R_g	$V_{DS} = 0V, V_{GS} = 0V, f = 1MHz$		2.1		Ω
Switching Characteristics						
Total Gate Charge	Q_g	$V_{DS} = 520V, V_{GS} = 10V, I_D = 12A$		39.8		nC
Gate-source Charge	Q_{gs}			9.2		
Gate-drain Charge	Q_{gd}			16.8		
Turn-on Delay Time	$t_{d(on)}$	$V_{DD} = 325V, I_D = 12A, R_G = 25\Omega, V_{GS} = 10V$		36		ns
Turn-on Rise Time	t_r			77		
Turn-off Delay Time	$t_{d(off)}$			120		
Turn-off Fall Time	t_f			63		
Source - Drain Diode Characteristics						
Diode Forward Voltage ⁴	V_{SD}	$V_{GS} = 0V, I_S = 2A$			1.2	V

Notes :

- 1.The maximum current rating is limited by package.And device mounted on a large heatsink
- 2.Pulse Test : Pulse Width $\leq 10\mu s$, duty cycle $\leq 1\%$.
- 3.E_{AS} condition: $V_{DD} = 100V, V_{GS} = 10V, L = 0.5mH, R_G = 25\Omega$ Starting $T_J = 25^\circ\text{C}$.
- 4.Pulse Test : Pulse Width $\leq 300\mu s$, duty cycle $\leq 2\%$.
- 5.The power dissipation P_D is limited by $T_{J(MAX)} = 150^\circ\text{C}$.And device mounted on a large heatsink
- 6.Device mounted on 1in² FR-4 board with 2oz. Copper, in a still air environment with $T_A = 25^\circ\text{C}$.

Typical Characteristics

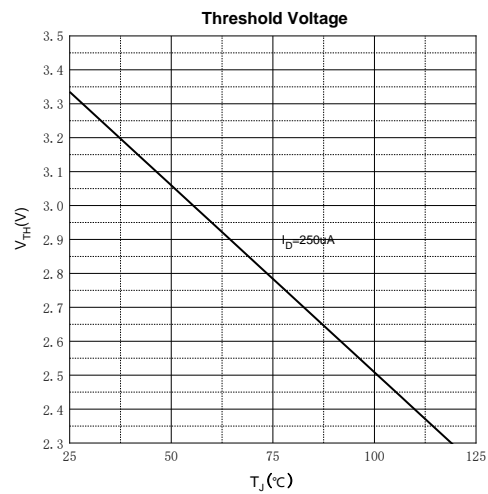
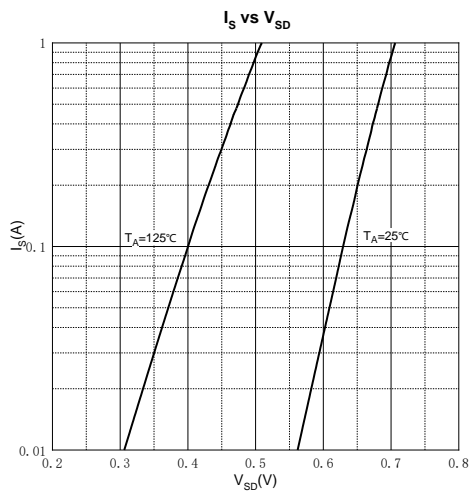
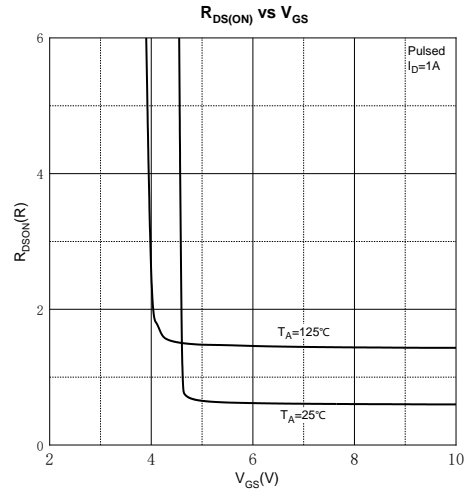
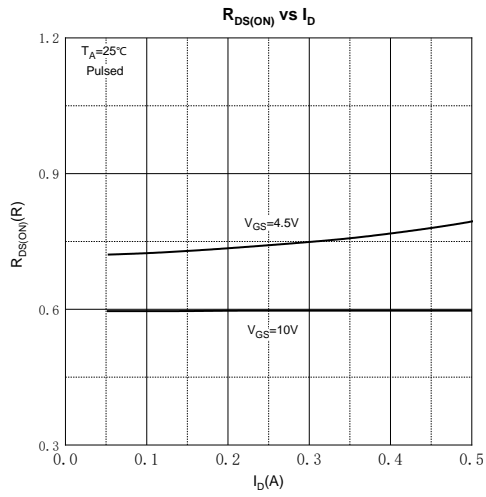
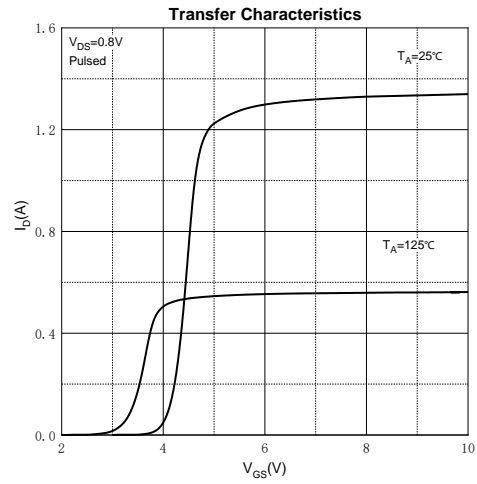
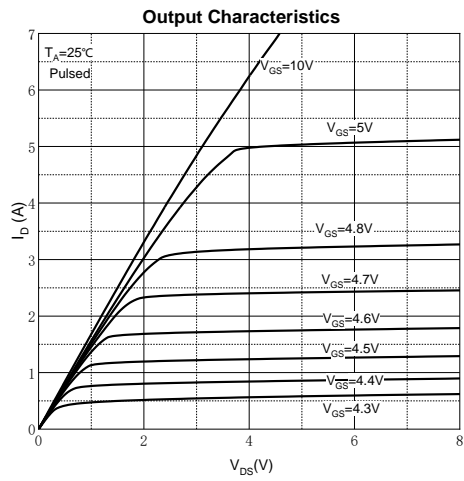

TO-220-3L-F Package Information

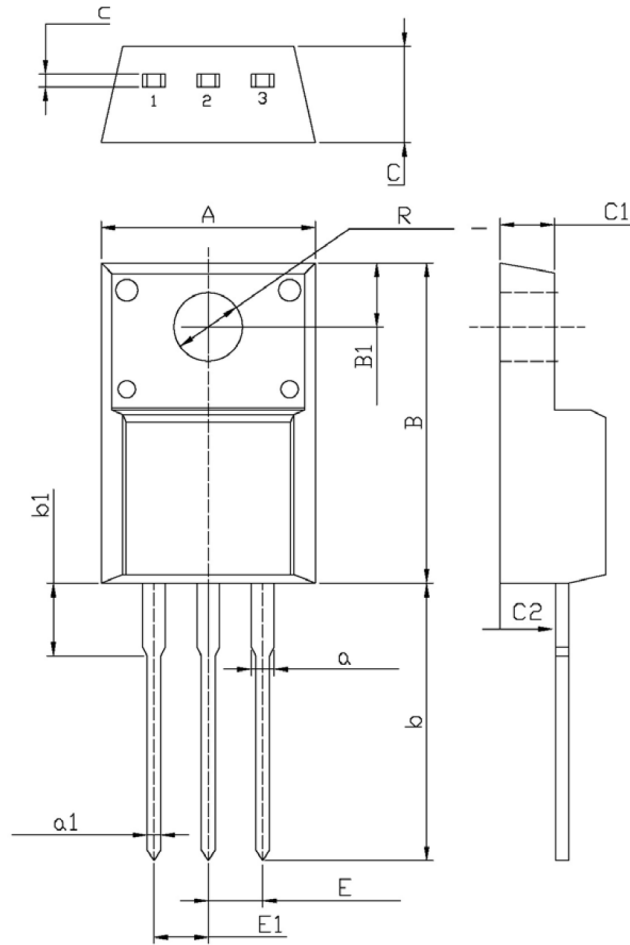

Symbol	Dimensions In Millimeters		Dimensions In Inches	
	Min.	Max.	Min.	Max.
C	4.500	4.900	0.177	0.193
c	0.400	0.600	0.016	0.024
A	9.960	10.360	0.392	0.408
B	15.670	16.070	0.617	0.633
B1	3.300	3.500	0.130	0.138
R	3.080	3.280	0.121	0.129
b	12.480	13.480	0.491	0.531
b1	2.900	3.900	0.114	0.154
a	1.080	1.480	0.043	0.058
a1	0.700	0.900	0.028	0.035
E	2.340	2.740	0.092	0.108
E1	2.340	2.740	0.092	0.108
C1	2.340	2.740	0.092	0.108
C2	2.560	2.960	0.101	0.117