



Product Summary

$V_{(BR)DSS}$	$R_{DS(on)TYP}$	I_D
30V	20mΩ@10V	5.8A
	27mΩ@4.5V	

Feature

- Trench Technology Power MOSFET
- Low $R_{DS(ON)}$
- Low Gate Resistance
- Low Gate Charge

Application

- Load Switch
- PMW

MARKING:

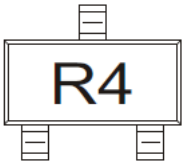

SOT-23

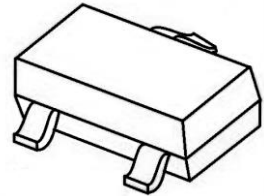

Schematic diagram

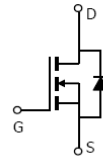

ABSOLUTE MAXIMUM RATINGS ($T_A = 25^\circ\text{C}$ unless otherwise noted)

Parameter	Symbol	Value	Unit
Drain - Source Voltage	V_{DS}	30	V
Gate - Source Voltage	V_{GS}	± 20	V
Continuous Drain Current ⁴	I_D	5.8	A
Pulsed Drain Current ^{1,4}	I_{DM}	23	A
Power Dissipation ^{3,4}	P_D	1	W
Thermal Resistance from Junction to Ambient ⁴	$R_{\theta JA}$	125	$^\circ\text{C/W}$
Junction Temperature	T_J	150	$^\circ\text{C}$
Storage Temperature	T_{STG}	-55~ +150	$^\circ\text{C}$

MOSFET ELECTRICAL CHARACTERISTICS ($T_J = 25^\circ\text{C}$ unless otherwise noted)

Parameter	Symbol	Test Condition	Min	Type	Max	Unit
Off Characteristics						
Drain - Source Breakdown Voltage	$V_{(BR)DSS}$	$V_{GS} = 0V, I_D = 250\mu A$	30			V
Zero Gate Voltage Drain Current	I_{DSS}	$V_{DS} = 24V, V_{GS} = 0V$			1	μA
Gate - Body Leakage Current	I_{GSS}	$V_{GS} = \pm 20V, V_{DS} = 0V$			± 100	nA
On Characteristics²						
Gate Threshold Voltage	$V_{GS(th)}$	$V_{DS} = V_{GS}, I_D = 250\mu A$	1.0	1.5	3.0	V
Drain-source On-resistance	$R_{DS(on)}$	$V_{GS} = 10V, I_D = 5.8A$		20	30	m Ω
		$V_{GS} = 4.5V, I_D = 4.8A$		27	42	
Forward Transconductance	g_{FS}	$V_{DS} = 5V, I_D = 5.8A$	20			S
Dynamic Characteristics						
Input Capacitance	C_{iss}	$V_{DS} = 15V, V_{GS} = 0V, f = 1MHz$		583		pF
Output Capacitance	C_{oss}			67		
Reverse Transfer Capacitance	C_{rss}			52		
Gate Resistance	R_g	$V_{DS} = 0V, V_{GS} = 0V, f = 1MHz$		2.0		Ω
Switching Characteristics						
Total Gate Charge	Q_g	$V_{DS} = 15V, V_{GS} = 10V, I_D = 5A$		9		nC
Gate-source Charge	Q_{gs}			1.6		
Gate-drain Charge	Q_{gd}			2.6		
Turn-on Delay Time	$t_{d(on)}$	$V_{DD} = 15V, V_{GS} = 10V, R_L = 3\Omega$ $R_G = 3\Omega$		9		ns
Turn-on Rise Time	t_r			5		
Turn-off Delay Time	$t_{d(off)}$			25		
Turn-off Fall Time	t_f			7		
Source - Drain Diode Characteristics						
Diode Forward Voltage ²	V_{SD}	$V_{GS} = 0V, I_S = 1A$			1.2	V

Notes :

- 1.Pulse Test : Pulse Width $\leq 10\mu s$, duty cycle $\leq 1\%$.
- 2.Pulse Test : Pulse Width $\leq 300\mu s$, duty cycle $\leq 2\%$.
- 3.The power dissipation P_D is limited by $T_{J(MAX)} = 150^\circ\text{C}$.
- 4.Device mounted on $1in^2$ FR-4 board with 2oz. Copper, in a still air environment with $T_A = 25^\circ\text{C}$.

Typical Characteristics

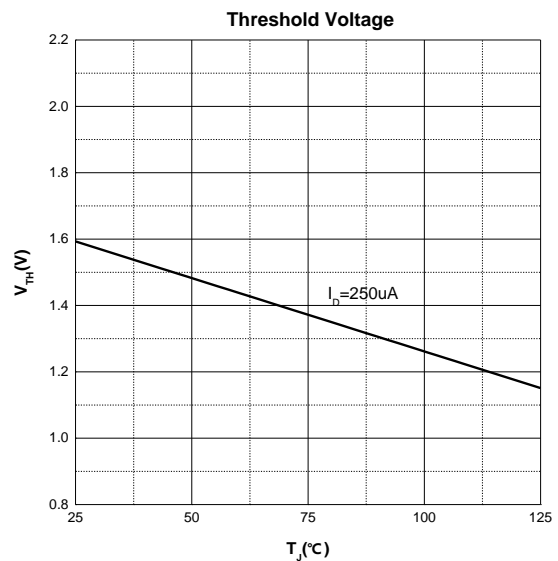
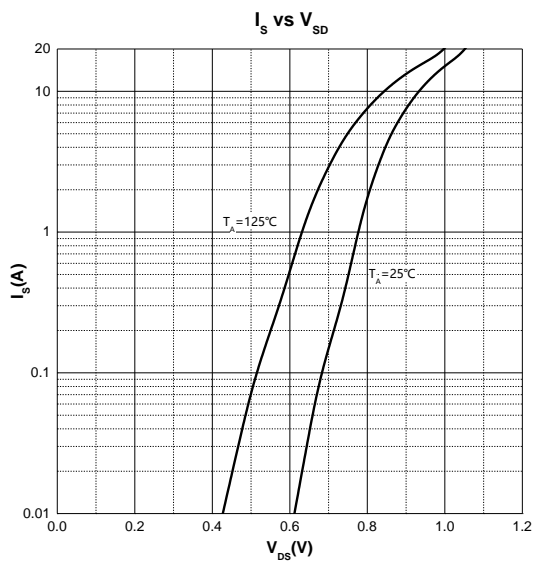
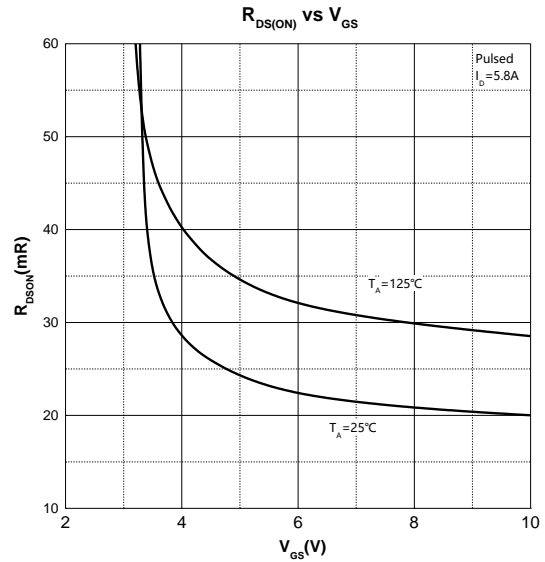
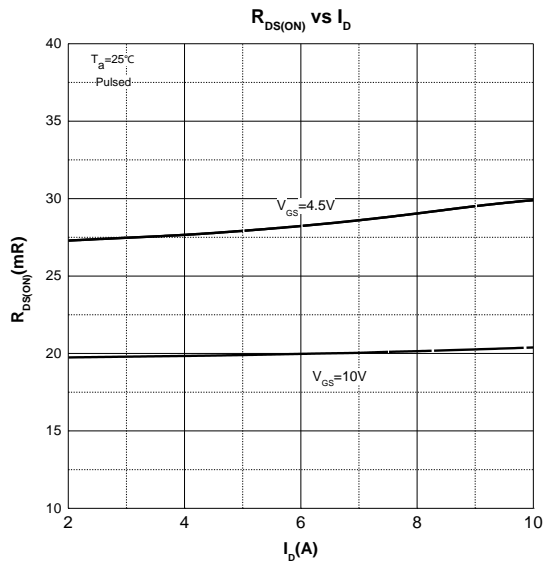
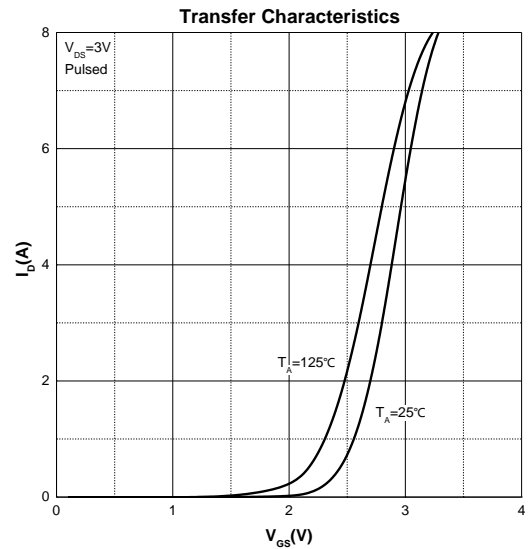
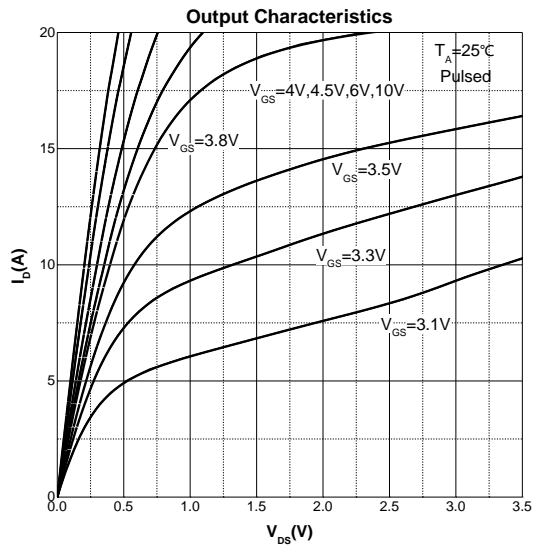

SOT-23 Package Information

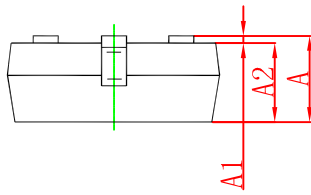
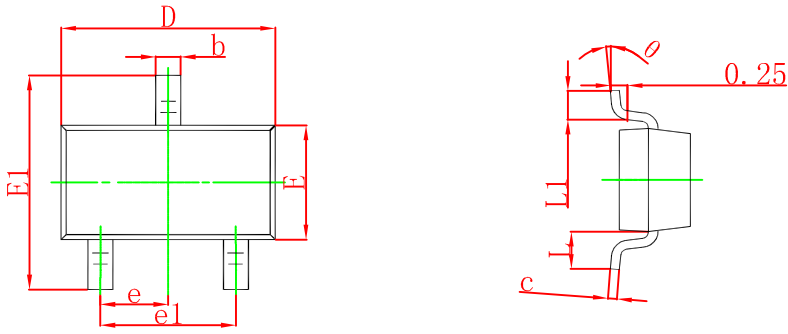

Symbol	Dimensions In Millimeters		Dimensions In Inches	
	Min	Max	Min	Max
A	0.900	1.150	0.035	0.045
A1	0.000	0.100	0.000	0.004
A2	0.900	1.050	0.035	0.041
b	0.300	0.500	0.012	0.020
c	0.080	0.150	0.003	0.006
D	2.800	3.000	0.110	0.118
E	1.200	1.400	0.047	0.055
E1	2.250	2.550	0.089	0.100
e	0.950 TYP		0.037 TYP	
e1	1.800	2.000	0.071	0.079
L	0.550 REF		0.022 REF	
L1	0.300	0.500	0.012	0.020
θ	0°	8°	0°	8°

SOT-23 Tape and Reel

SOT-23 Embossed Carrier Tape

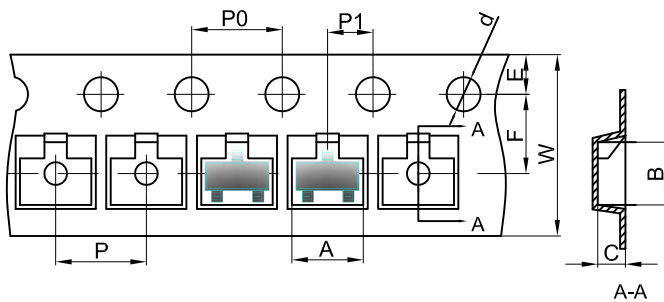

Dimensions are in millimeter											
Pkg type	A	B	C	d	E	F	P0	P	P1	W	
SOT-23	3.15	2.77	1.22	Ø1.50	1.75	3.50	4.00	4.00	2.00	8.00	

SOT-23 Tape Leader and Trailer

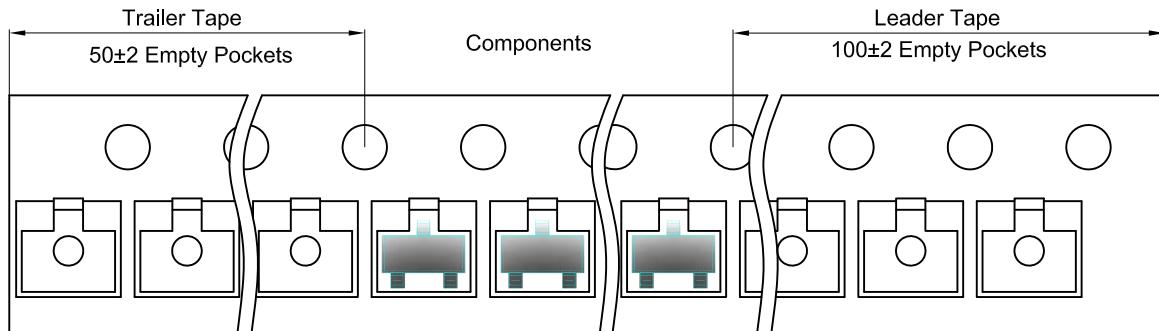

SOT-23 Reel

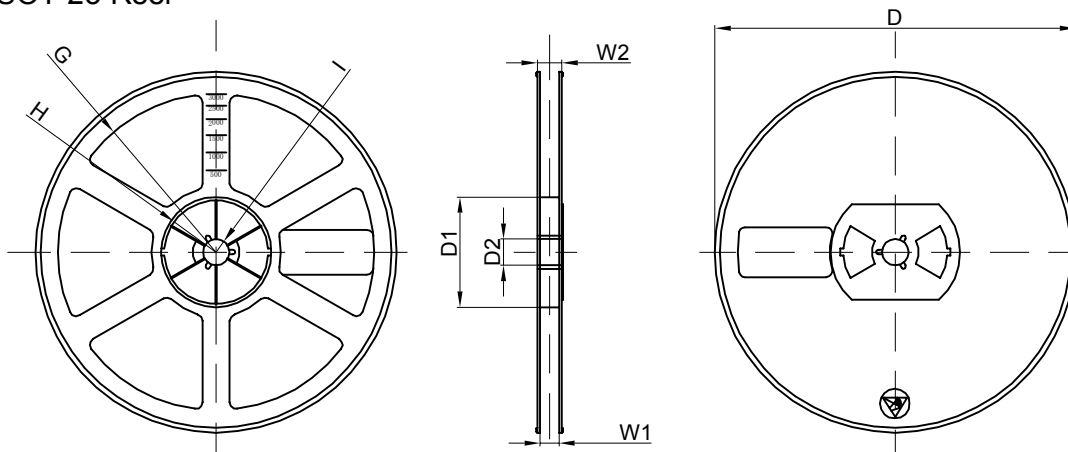

Dimensions are in millimeter									
Reel Option	D	D1	D2	G	H	I	W1	W2	
7" Dia	Ø178.00	54.40	13.00	R78.00	R25.60	R6.50	9.50	12.30	

REEL	Reel Size	Box	Box Size(mm)	Carton	Carton Size(mm)	G.W.(kg)
3000 pcs	7 inch	30,000 pcs	203×203×195	120,000 pcs	438×438×220	