

Product Summary

$V_{(BR)DSS}$	$R_{DS(on)TYP}$	I_D
60V	0.9Ω@10V	0.34A
	1.1Ω@4.5V	

Feature

- Low On-Resistance
- Low Threshold Voltage
- Fast Switching Speed
- ESD Protected Gate

Application

- Load Switch
- Portable Applications
- Power Management Functions

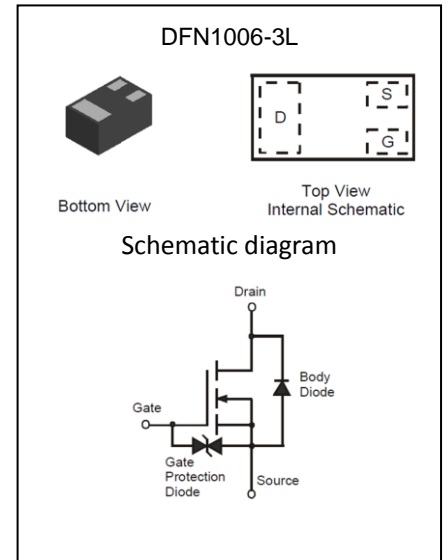

MARKING:

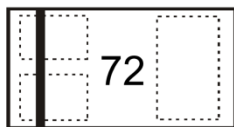

Top View
Bar Denotes Gate and Source Side

ABSOLUTE MAXIMUM RATINGS ($T_a=25^{\circ}C$ unless otherwise noted)

Parameter	Symbol	Value	Unit
Drain-Source Voltage	V_{DS}	60	V
Gate-Source Voltage	V_{GS}	±20	V
Continuous Drain Current	I_D	$T_a=25^{\circ}C$	0.34
		$T_a=85^{\circ}C$	0.30
Pulsed Drain Current	I_{DM}	1.2	A
Power Dissipation	P_D	0.1	W
Thermal Resistance from Junction to Ambient	$R_{\theta JA}$	1250	$^{\circ}C/W$
Storage Temperature	T_{STG}	-55~ +150	$^{\circ}C$

MOSFET ELECTRICAL CHARACTERISTICS(T_a=25°C unless otherwise noted)

Parameter	Symbol	Test Condition	Min	Type	Max	Unit
Static Characteristics						
Drain-source breakdown voltage	V _{(BR)DSS}	V _{GS} = 0V, I _D = 250μA	60			V
Zero gate voltage drain current	I _{DSS}	V _{DS} = 60V, V _{GS} = 0V			100	nA
Gate-body leakage current	I _{GSS}	V _{GS} = ±20V, V _{DS} = 0V			±10	μA
		V _{GS} = ±5V, V _{DS} = 0V			±1	
Gate threshold voltage	V _{GS(th)}	V _{DS} = V _{GS} , I _D = 250μA	1.0	1.4	2.5	V
Drain-source on-resistance ^a	R _{DS(on)}	V _{GS} = 10V, I _D = 40mA		0.9	2.5	Ω
		V _{GS} = 4.5V, I _D = 35mA		1.1	3.0	
Forward transconductance ^a	g _{fs}	V _{DS} = 5V, I _D = 40mA	100			mS
Diode forward voltage	V _{SD}	V _{DS} = 0V, I _S = 300mA		0.84	1.1	V
Dynamic characteristics						
Input Capacitance ^b	C _{iss}	V _{DS} = 40V, V _{GS} = 0V, f = 1MHz		41	80	pF
Output Capacitance ^b	C _{oss}			3.6	7	
Reverse Transfer Capacitance ^b	C _{rss}			2.9	5.6	
Gate resistance	R _g	V _{DS} = 0V, V _{GS} = 0V, f = 1MHz		81	200	Ω
Total Gate Charge	Q _g	V _{GS} = 4.5V	V _{DS} = 50V, I _D = 1A	0.72	1.5	nC
Gate-Source Charge	Q _{gs}	V _{GS} = 10V		1.41	2.8	
Gate-Drain Charge	Q _{gd}			0.24	0.4	
Turn-on delay time ^b	t _{d(on)}			0.24	0.5	
Turn-on rise time ^b	t _r	V _{DS} = 50V, I _D = 1A,		3.98	10	ns
Turn-off delay time ^b	t _{d(off)}	V _{GS} = 10V, R _G = 6Ω		4.95	10	
Turn-off fall time ^b	t _f			18.52	40	
				11.94	25	

Notes:

- a. Pulse Test : Pulse width ≤ 300μs, duty cycle ≤ 2%.
- b. These parameters have no way to verify.

Typical Electrical and Thermal Characteristics

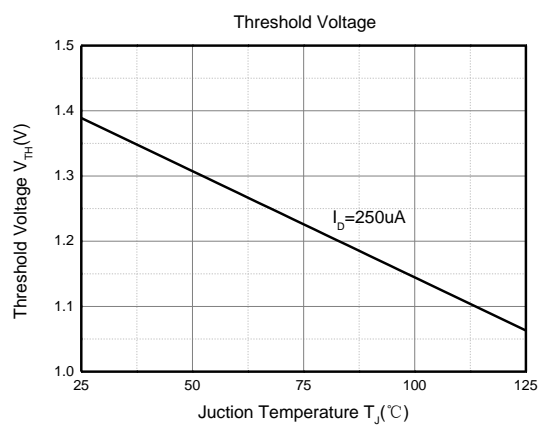
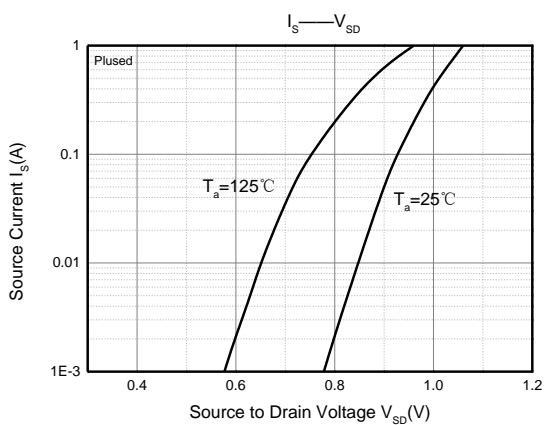
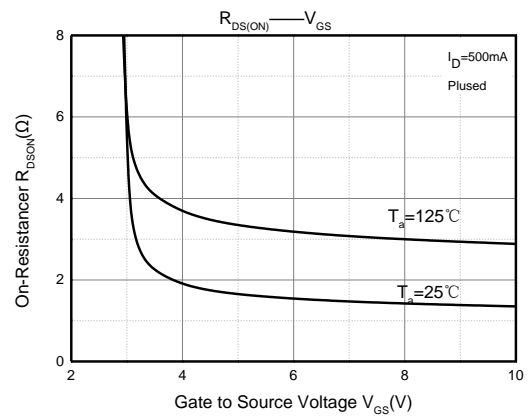
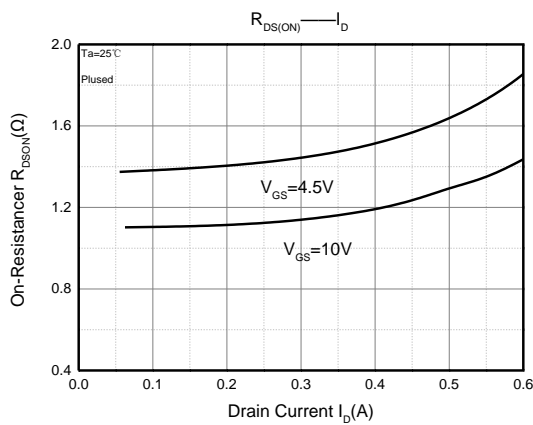
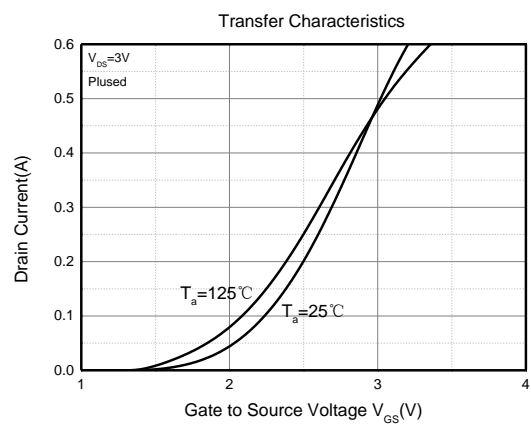
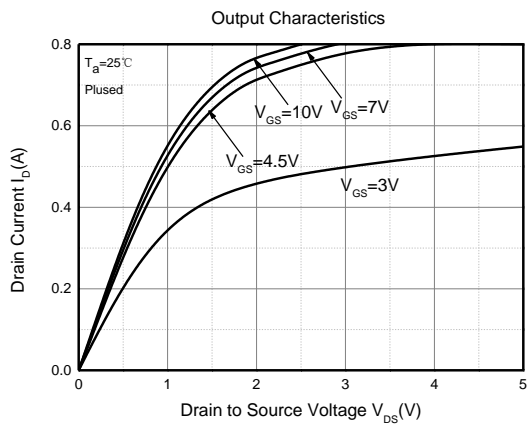

DFN1006-3L Package Information

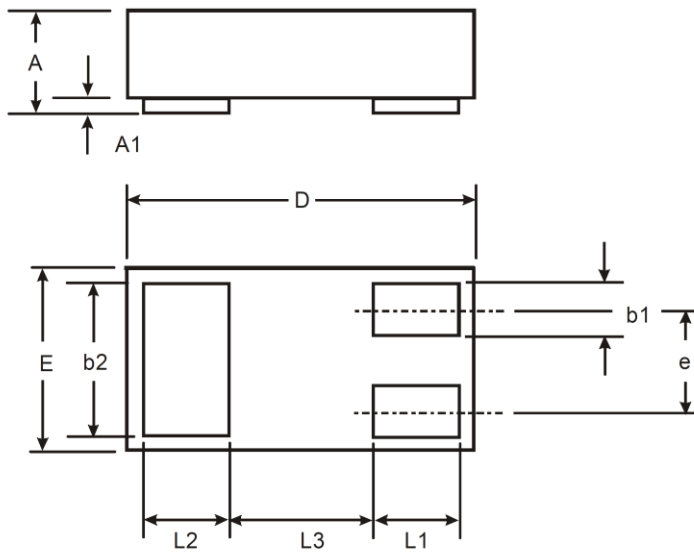

X1-DFN1006-3			
Dim	Min	Max	Typ
A	0.47	0.53	0.50
A1	0	0.05	0.03
b1	0.10	0.20	0.15
b2	0.45	0.55	0.50
D	0.95	1.075	1.00
E	0.55	0.675	0.60
e	—	—	0.35
L1	0.20	0.30	0.25
L2	0.20	0.30	0.25
L3	—	—	0.40
All Dimensions in mm			

DFN1006-3L Tape and Reel

DFN1006-3L Embossed Carrier Tape

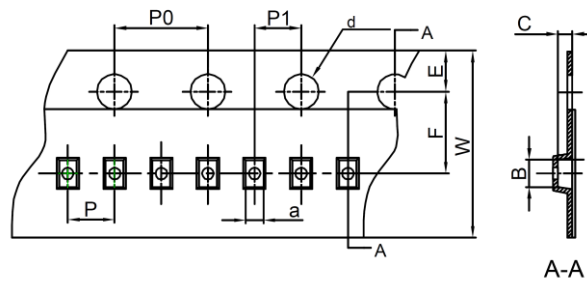

Dimensions are in millimeter										
Pkg type	a	B	C	d	E	F	P0	P	P1	W
DFN1006-3L	0.66	1.15	0.66	Ø1.50	1.75	3.50	4.00	2.00	2.00	8.00

DFN1006-3L Tape Leader and Trailer

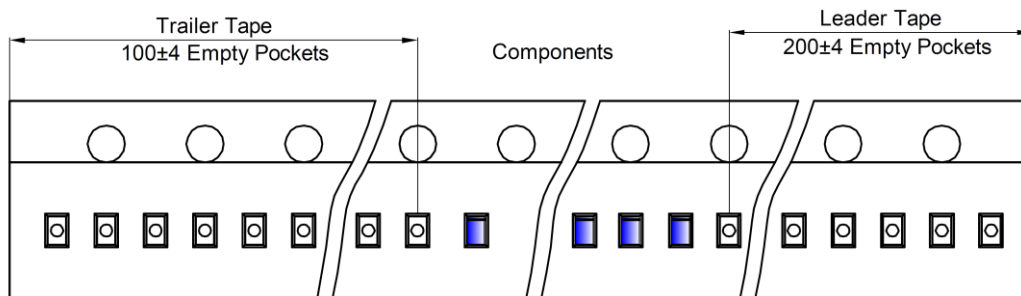

DFN1006-3L Reel

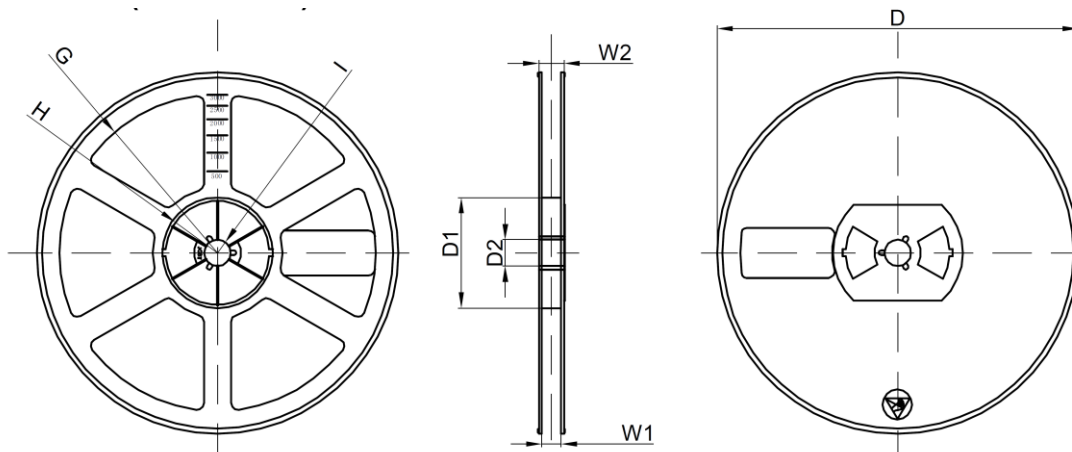

Dimensions are in millimeter								
Reel Option	D	D1	D2	G	H	I	W1	W2
7" Dia	Ø178.00	54.40	13.00	R78.00	R25.60	R6.50	9.50	12.30

REEL	Reel Size	Box	Box Size(mm)	Carton	Carton Size(mm)	G.W.(kg)
10000 pcs	7 inch	100,000 pcs	203×203×195	400,000 pcs	438×438×220	