



Product Summary

$V_{(BR)DSS}$	$R_{DS(on)TYP}$	I_D
-30V	85mΩ@-10V	-1.9A
	125mΩ@-4.5V	

Feature

- Trench Technology Power MOSFET
- Low $R_{DS(ON)}$
- Low Gate Charge
- Low Gate Resistance

Application

- DC/DC Converter
- Power Management

MARKING:

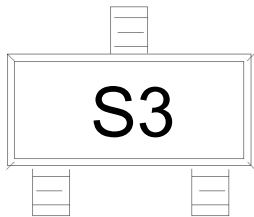

SOT-23

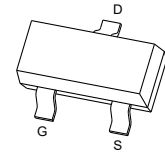

Schematic diagram

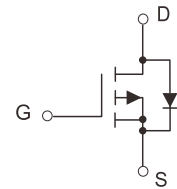

ABSOLUTE MAXIMUM RATINGS ($T_A = 25^\circ\text{C}$ unless otherwise noted)

Parameter	Symbol	Value	Unit
Drain - Source Voltage	V_{DS}	-30	V
Gate - Source Voltage	V_{GS}	±20	V
Continuous Drain Current ^{1,5}	I_D	-1.9	A
Pulsed Drain Current ²	I_{DM}	-7.6	A
Power Dissipation ^{4,5}	P_D	0.63	W
Thermal Resistance from Junction to Ambient ⁵	$R_{\theta JA}$	200	$^\circ\text{C}/\text{W}$
Junction Temperature	T_J	150	$^\circ\text{C}$
Storage Temperature	T_{STG}	-55~ +150	$^\circ\text{C}$

MOSFET ELECTRICAL CHARACTERISTICS ($T_J = 25^\circ\text{C}$ unless otherwise noted)

Parameter	Symbol	Test Condition	Min	Type	Max	Unit
Off Characteristics						
Drain - Source Breakdown Voltage	$V_{(BR)DSS}$	$V_{GS} = 0V, I_D = -250\mu A$	-30			V
Zero Gate Voltage Drain Current	I_{DSS}	$V_{DS} = -24V, V_{GS} = 0V$			-1	μA
Gate - Body Leakage Current	I_{GSS}	$V_{GS} = \pm 20V, V_{DS} = 0V$			± 100	nA
On Characteristics³						
Gate Threshold Voltage	$V_{GS(th)}$	$V_{DS} = V_{GS}, I_D = -250\mu A$	-1	-1.5	-3.0	V
Drain-source On-resistance	$R_{DS(on)}$	$V_{GS} = -10V, I_D = -1.9A$		85	150	m Ω
		$V_{GS} = -4.5V, I_D = -1.4A$		125	250	
Forward Transconductance	g_{FS}	$V_{DS} = -5V, I_D = -1.9A$	2			S
Dynamic Characteristics						
Input Capacitance	C_{iss}	$V_{DS} = -15V, V_{GS} = 0V, f = 1MHz$		266		pF
Output Capacitance	C_{oss}			37		
Reverse Transfer Capacitance	C_{rss}			25		
Switching Characteristics						
Total Gate Charge	Q_g	$V_{DS} = -15V, V_{GS} = -10V, I_D = -1.9A$		5.8		nC
Gate-source Charge	Q_{gs}			3.2		
Gate-drain Charge	Q_{gd}			0.9		
Turn-on Delay Time	$t_{d(on)}$	$V_{DD} = -15V, V_{GS} = -10V,$ $R_L = 7.5\Omega, R_G = 3\Omega$		6		ns
Turn-on Rise Time	t_r			4		
Turn-off Delay Time	$t_{d(off)}$			15		
Turn-off Fall Time	t_f			6		
Source - Drain Diode Characteristics						
Diode Forward Voltage ³	V_{SD}	$V_{GS} = 0V, I_S = -1.5A$			-1.2	V

Notes :

- 1.The maximum current rating is limited by Package.
- 2.Pulse Test : Pulse Width $\leq 10\mu s$, duty cycle $\leq 1\%$.
- 3.Pulse Test : Pulse Width $\leq 300\mu s$, duty cycle $\leq 2\%$.
- 4.The power dissipation P_D is limited by $T_{J(MAX)} = 150^\circ\text{C}$.
- 5.Device mounted on $1in^2$ FR-4 board with 2oz. Copper, in a still air environment with $T_A = 25^\circ\text{C}$.

Typical Characteristics

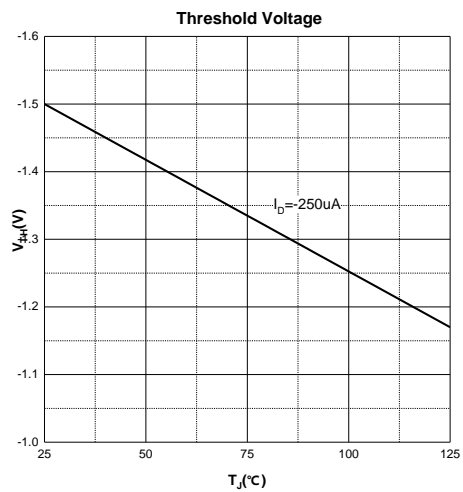
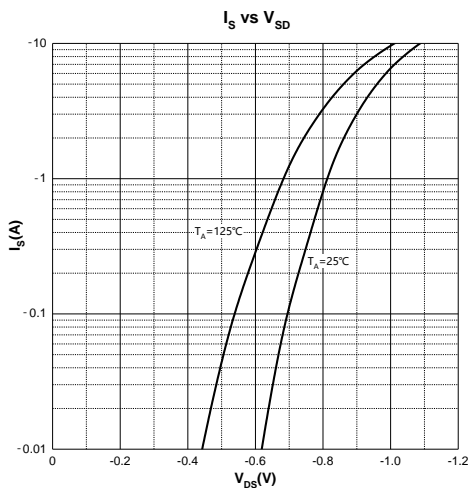
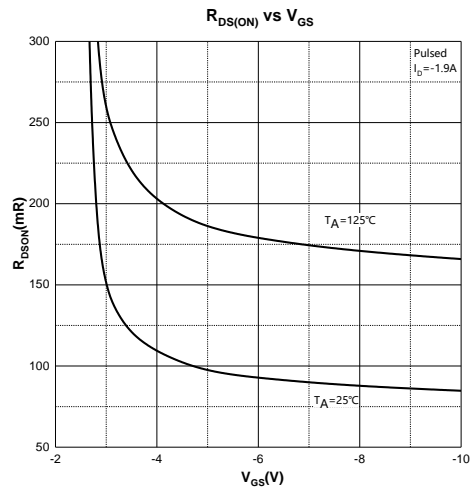
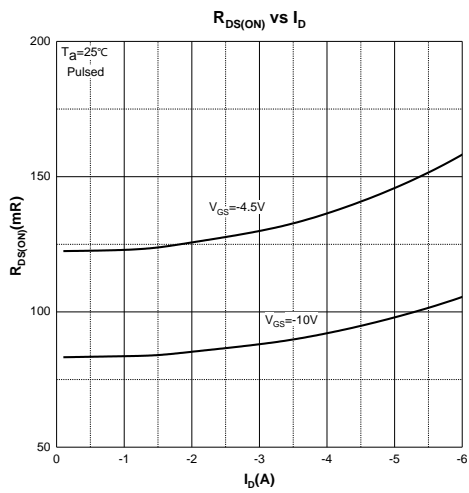
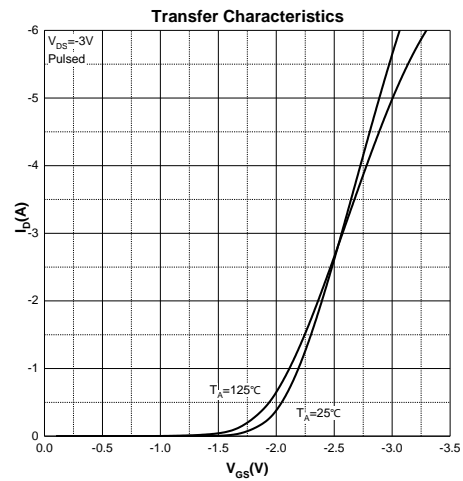
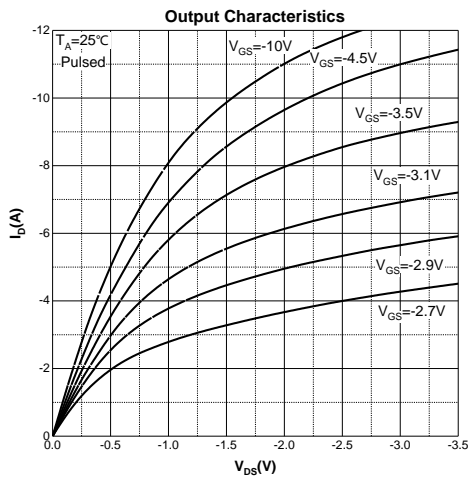

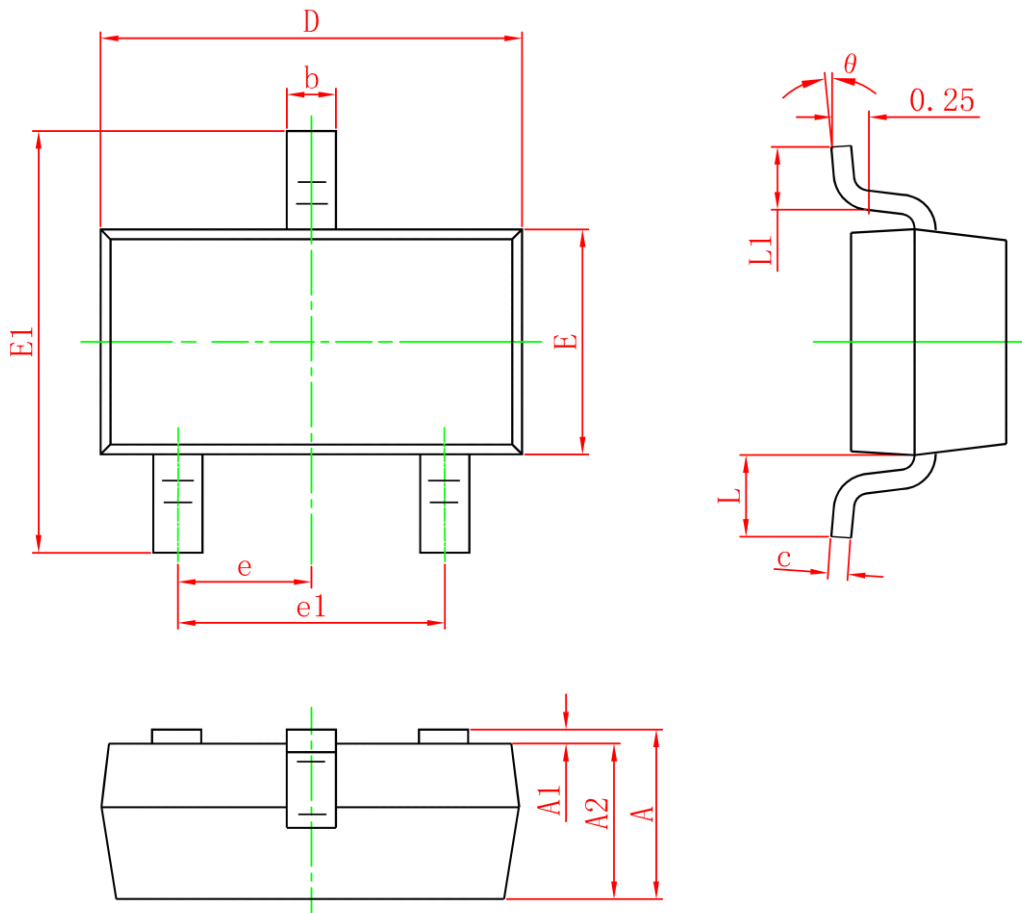
SOT-23 Package Information

Symbol	Dimensions In Millimeters		Dimensions In Inches	
	Min.	Max.	Min.	Max.
A	0.900	1.150	0.035	0.045
A1	0	0.100	0	0.004
A2	0.900	1.050	0.035	0.041
b	0.300	0.500	0.012	0.020
c	0.080	0.150	0.003	0.006
D	2.800	3.000	0.110	0.118
E	1.150	1.500	0.045	0.059
E1	2.250	2.650	0.089	0.104
e	0.950TYP		0.037TYP	
e1	1.800	2.000	0.071	0.079
L	0.550REF		0.022REF	
L1	0.300	0.500	0.012	0.020
θ	0°	8°	0°	8°