



#### Product Summary

$V_{(BR)DSS}$	$R_{DS(on)TYP}$	$I_D$
-30V	60mΩ@-10V	-2.7A
	90mΩ@-4.5V	

#### Feature

- TrenchFET Power MOSFET
- Excellent  $R_{DS(on)}$  and Low Gate Charge

#### Application

- DC/DC Converter
- Load Switch for Portable Devices
- Battery Switch

#### MARKING:

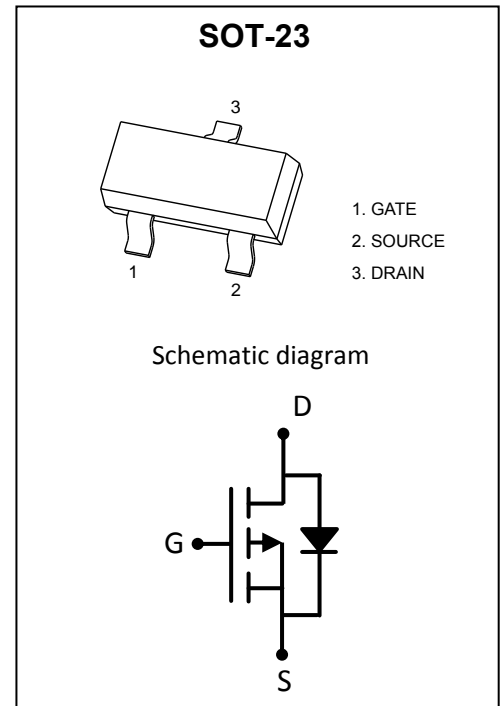
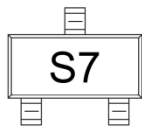

#### ABSOLUTE MAXIMUM RATINGS ( $T_a=25^{\circ}\text{C}$ unless otherwise noted)

Parameter	Symbol	Value	Unit
Drain-Source Voltage	$V_{DS}$	-30	V
Gate-Source Voltage	$V_{GS}$	$\pm 20$	V
Continuous Drain Current	$I_D$	-2.7	A
Continuous Source-Drain Current	$I_S$	-0.91	A
Power Dissipation	$P_D$	1.1	W
Thermal Resistance from Junction to Ambient	$R_{\theta JA}$	114	$^{\circ}\text{C}/\text{W}$
Junction Temperature	$T_J$	150	$^{\circ}\text{C}$
Storage Temperature	$T_{STG}$	-55~ +150	$^{\circ}\text{C}$

**MOSFET ELECTRICAL CHARACTERISTICS( $T_a=25^{\circ}\text{C}$  unless otherwise noted)**

Parameter	Symbol	Test Condition	Min	Type	Max	Unit
<b>Static Characteristics</b>						
Drain-source breakdown voltage	$V_{(BR)DSS}$	$V_{GS} = 0V, I_D = -250\mu A$	-30			V
Zero gate voltage drain current	$I_{DSS}$	$V_{DS} = -30V, V_{GS} = 0V$			-1	$\mu A$
Gate-body leakage current	$I_{GSS}$	$V_{GS} = \pm 20V, V_{DS} = 0V$			$\pm 100$	nA
Gate threshold voltage	$V_{GS(th)}$	$V_{DS} = V_{GS}, I_D = -250\mu A$	-1	-1.5	-3	V
Drain-source on-resistance <sup>a</sup>	$R_{DS(on)}$	$V_{GS} = -10V, I_D = -3.5A$		60	88	m $\Omega$
		$V_{GS} = -4.5V, I_D = -2.5A$		90	138	
Forward transconductance <sup>a</sup>	$g_{FS}$	$V_{DS} = -10V, I_D = -3.5A$	1			S
<b>Dynamic characteristics<sup>b</sup></b>						
Input Capacitance	$C_{iss}$	$V_{DS} = -15V, V_{GS} = 0V, f = 1MHz$		340		pF
Output Capacitance	$C_{oss}$			67		
Reverse Transfer Capacitance	$C_{rss}$			51		
Total Gate Charge	$Q_g$	$V_{DS} = -15V, V_{GS} = -4.5V, I_D = -2.5A$		4.1		nC
Gate-Source Charge	$Q_{gs}$			1.2		
Gate-Drain Charge	$Q_{gd}$			1.7		
Turn-on delay time	$t_{d(on)}$	$V_{DD} = -15V, V_{GEN} = -4.5V, I_D = -1A$ $R_L = 15\Omega, R_{GEN} = 1\Omega$		39		ns
Turn-on rise time	$t_r$			40		
Turn-off delay time	$t_{d(off)}$			20		
Turn-off fall time	$t_f$			17		
<b>Source-Drain Diode characteristics</b>						
Diode Forward voltage	$V_{DS}$	$V_{GS} = 0V, I_S = -1.5A$		-0.85	-1.2	V

**Notes:**

- a. Pulse Test : Pulse Width < 300 $\mu s$ , Duty Cycle  $\leq 2\%$ .  
b. Guaranteed by design, not subject to production testing.

**Typical Electrical and Thermal Characteristics**

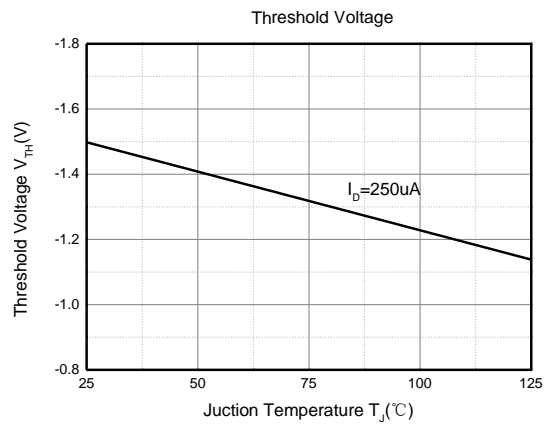
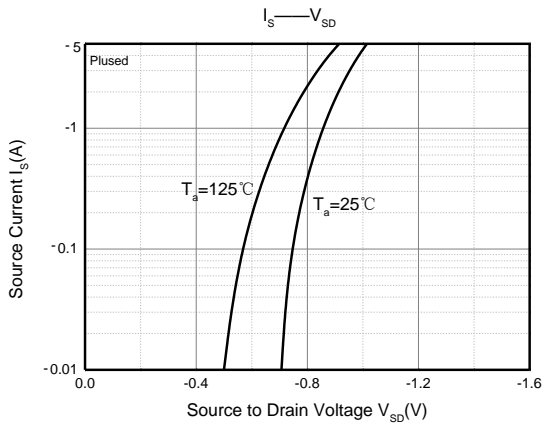
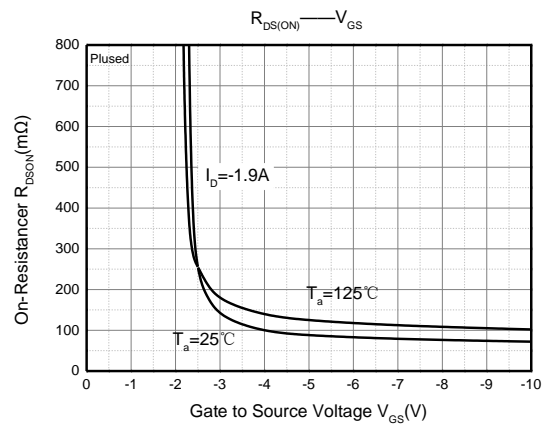
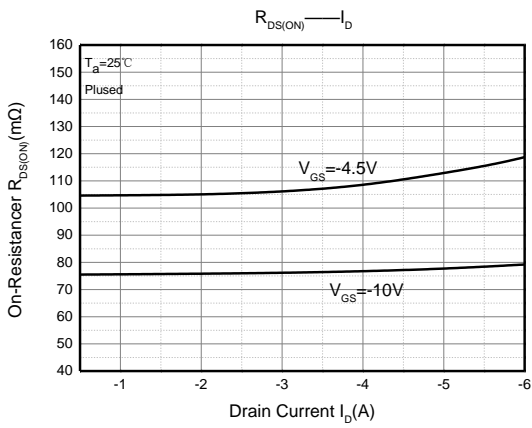
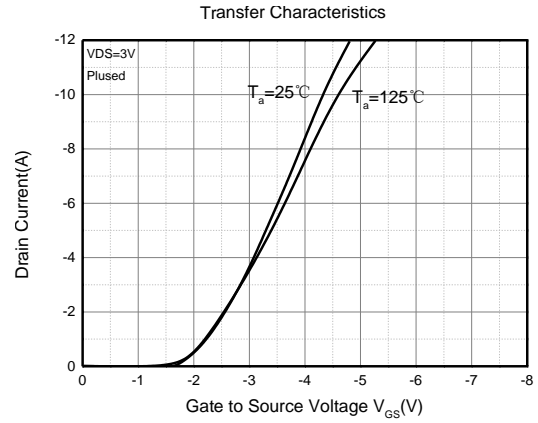
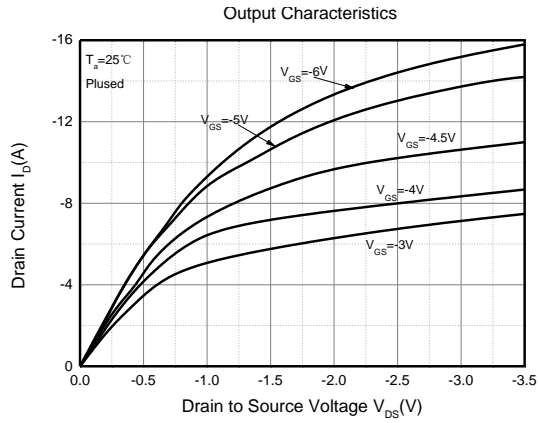

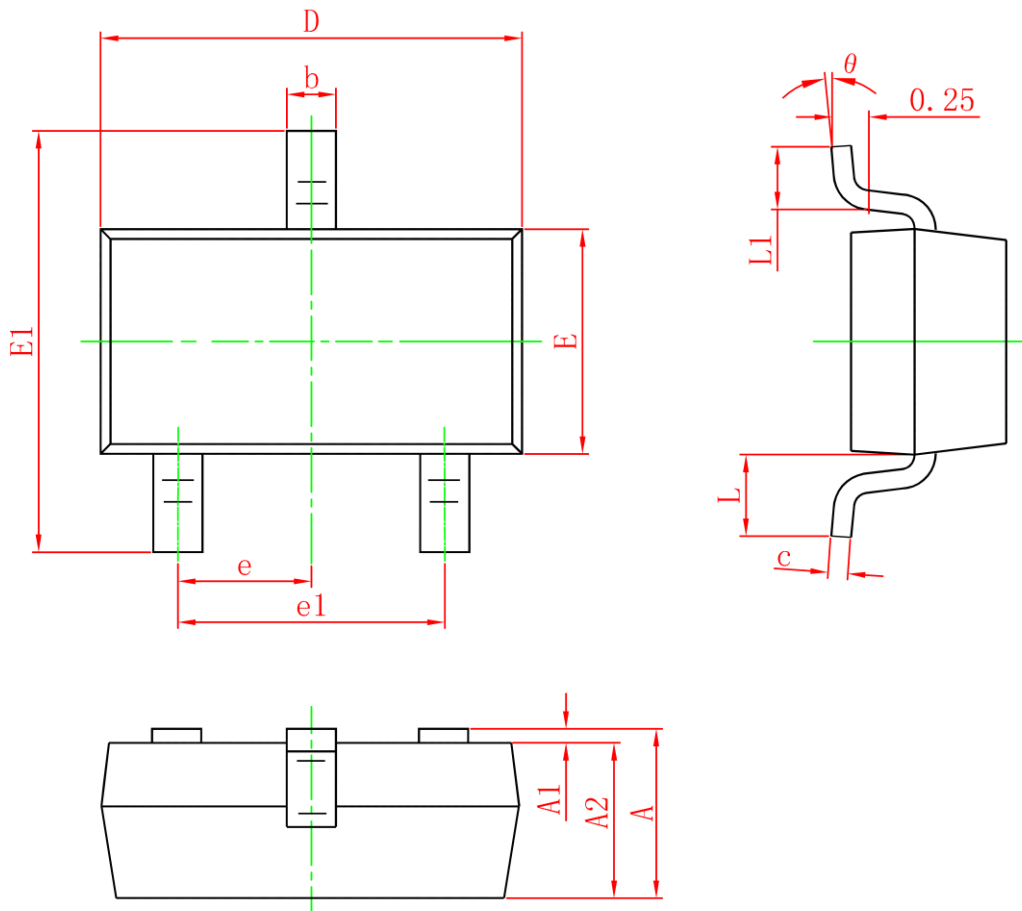
**SOT-23 Package Information**

Symbol	Dimensions In Millimeters		Dimensions In Inches	
	Min.	Max.	Min.	Max.
A	0.900	1.150	0.035	0.045
A1	0	0.100	0	0.004
A2	0.900	1.050	0.035	0.041
b	0.300	0.500	0.012	0.020
c	0.080	0.150	0.003	0.006
D	2.800	3.000	0.110	0.118
E	1.150	1.500	0.045	0.059
E1	2.250	2.650	0.089	0.104
e	0.950TYP		0.037TYP	
e1	1.800	2.000	0.071	0.079
L	0.550REF		0.022REF	
L1	0.300	0.500	0.012	0.020
$\theta$	0°	8°	0°	8°