



### Product Summary

$V_{(BR)DSS}$	$R_{DS(on)TYP}$	$I_D$
-30V	6.5mΩ@-10V	-45A
	10mΩ@-4.5V	

### Feature

- Trench Technology Power MOSFET
- Low  $R_{DS(ON)}$
- Low Gate Charge
- Low Gate Resistance
- 100% UIS Tested

### Application

- Power Switching Application

### MARKING:



M080P03A = Device Code  
XX = Date Code  
Solid Dot = Green Indicator

### ABSOLUTE MAXIMUM RATINGS ( $T_A = 25^\circ\text{C}$ unless otherwise noted)

Parameter	Symbol	Value	Unit	
Drain - Source Voltage	$V_{DS}$	-30	V	
Gate - Source Voltage	$V_{GS}$	±20	V	
Continuous Drain Current <sup>1</sup>	$I_D$	$T_C = 25^\circ\text{C}$	-45	A
Continuous Drain Current <sup>1</sup>		$T_C = 100^\circ\text{C}$	-28	A
Pulsed Drain Current <sup>2</sup>	$I_{DM}$	-180	A	
Single Pulsed Avalanche Current <sup>3</sup>	$I_{AS}$	-37	A	
Single Pulsed Avalanche Energy <sup>3</sup>	$E_{AS}$	342	mJ	
Power Dissipation <sup>5</sup>	$P_D$	$T_C = 25^\circ\text{C}$	30	W
Thermal Resistance from Junction to Ambient <sup>6</sup>		$R_{\theta JA}$	55	$^\circ\text{C}/\text{W}$
Thermal Resistance from Junction to Case	$R_{\theta JC}$	4.2	$^\circ\text{C}/\text{W}$	
Junction Temperature	$T_J$	150	$^\circ\text{C}$	
Storage Temperature	$T_{STG}$	-55~ +150	$^\circ\text{C}$	

### PDFN3.3×3.3-8L

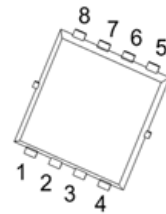

### Schematic diagram

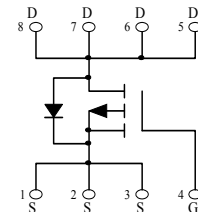

## MOSFET ELECTRICAL CHARACTERISTICS ( $T_J = 25^\circ\text{C}$ unless otherwise noted)

Parameter	Symbol	Test Condition	Min	Type	Max	Unit
<b>Off Characteristics</b>						
Drain - Source Breakdown Voltage	$V_{(BR)DSS}$	$V_{GS} = 0V, I_D = -250\mu A$	-30			V
Zero Gate Voltage Drain Current	$I_{DSS}$	$V_{DS} = -30V, V_{GS} = 0V$			-1	$\mu A$
Gate - Body Leakage Current	$I_{GSS}$	$V_{GS} = \pm 20V, V_{DS} = 0V$			$\pm 100$	nA
<b>On Characteristics<sup>4</sup></b>						
Gate Threshold Voltage	$V_{GS(th)}$	$V_{DS} = V_{GS}, I_D = -250\mu A$	-1.0	-1.5	-3.0	V
Drain-source On-resistance	$R_{DS(on)}$	$V_{GS} = -10V, I_D = -20A$		6.5	8.0	m $\Omega$
		$V_{GS} = -4.5V, I_D = -16A$		10	13	
Forward Transconductance	$g_{FS}$	$V_{DS} = -10V, I_D = -5.0A$	10			S
<b>Dynamic Characteristics</b>						
Input Capacitance	$C_{iss}$	$V_{DS} = -15V, V_{GS} = 0V, f = 1MHz$		3141		pF
Output Capacitance	$C_{oss}$			526		
Reverse Transfer Capacitance	$C_{rss}$			481		
Gate Resistance	$R_g$	$V_{DS} = 0V, V_{GS} = 0V, f = 1MHz$		4.6		$\Omega$
<b>Switching Characteristics</b>						
Total Gate Charge	$Q_g$	$V_{DS} = -15V, V_{GS} = -10V, I_D = -20A$		64.5		nC
Gate-source Charge	$Q_{gs}$			7.6		
Gate-drain Charge	$Q_{gd}$			13.8		
Turn-on Delay Time	$t_{d(on)}$	$V_{DD} = -15V, V_{GS} = -10V,$ $R_L = 0.75\Omega, R_G = 3\Omega$		13		ns
Turn-on Rise Time	$t_r$			19		
Turn-off Delay Time	$t_{d(off)}$			130		
Turn-off Fall Time	$t_f$			67		
<b>Source - Drain Diode Characteristics</b>						
Diode Forward Voltage <sup>4</sup>	$V_{SD}$	$V_{GS} = 0V, I_S = -20A$			-1.2	V

Notes :

- 1.The maximum current rating is limited by package.And device mounted on a large heatsink
- 2.Pulse Test : Pulse Width  $\leq 10\mu s$ , duty cycle  $\leq 1\%$ .
- 3.EAS condition:  $V_{DD} = -30V, V_{GS} = -10V, L = 0.5mH, R_G = 25\Omega$  Starting  $T_J = 25^\circ\text{C}$ .
- 4.Pulse Test : Pulse Width  $\leq 300\mu s$ , duty cycle  $\leq 2\%$ .
- 5.The power dissipation  $P_D$  is limited by  $T_{J(MAX)} = 150^\circ\text{C}$ .And device mounted on a large heatsink
- 6.Device mounted on  $1in^2$  FR-4 board with 2oz. Copper, in a still air environment with  $T_A = 25^\circ\text{C}$ .

## Typical Characteristics

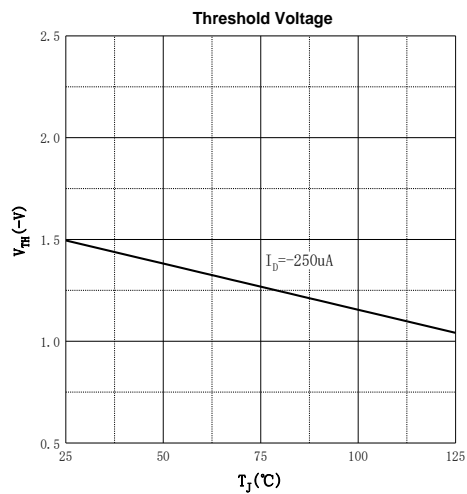
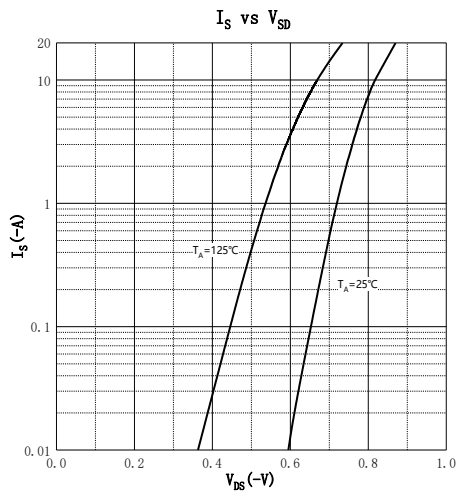
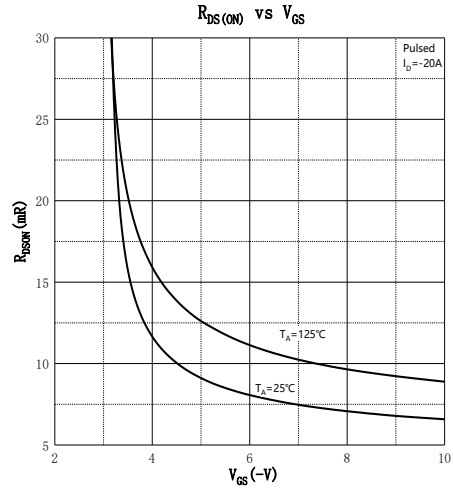
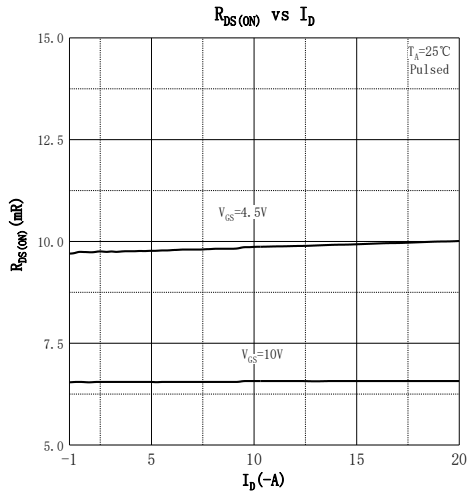
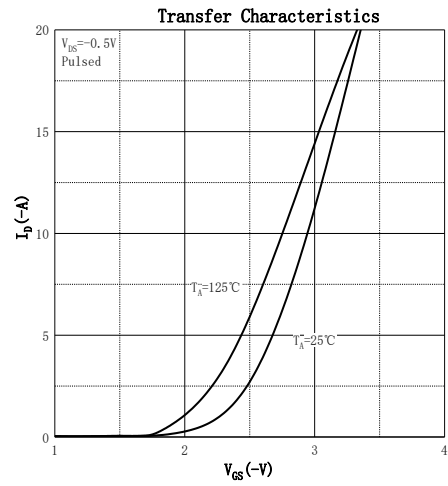
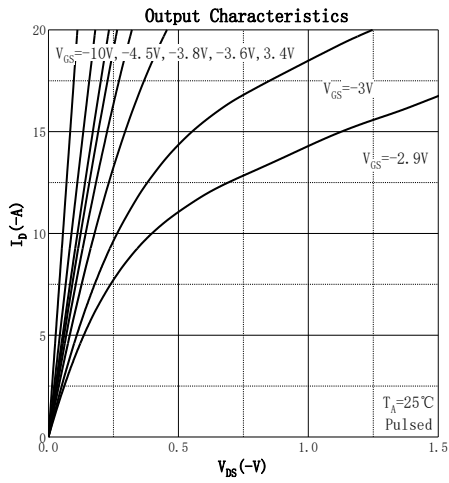

## PDFN3.3×3.3-8L Package Information

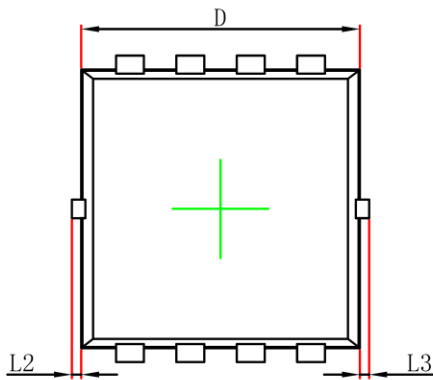

Top View  
[顶视图]

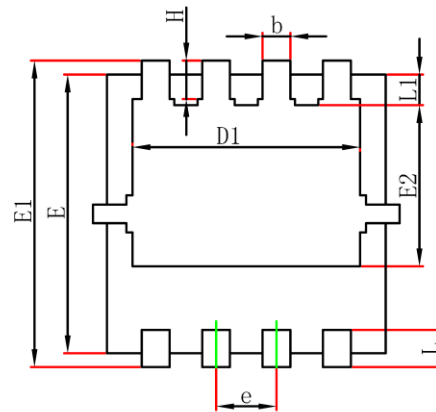

Bottom View  
[背视图]

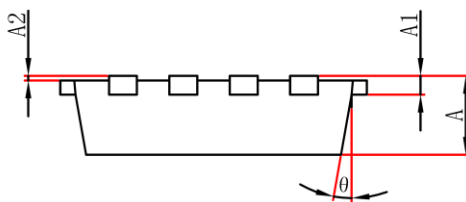

Side View  
[侧视图]

Symbol	Dimensions In Millimeters		Dimensions In Inches	
	Min.	Max.	Min.	Max.
A	0.700	0.900	0.028	0.035
A1	0.152REF		0.006REF	
A2	0.000	0.050	0.000	0.002
D	2.900	3.200	0.114	0.126
D1	2.300	2.600	0.091	0.102
E	2.900	3.200	0.114	0.126
E1	3.150	3.450	0.124	0.136
E2	1.535	1.935	0.060	0.076
b	0.200	0.400	0.008	0.016
e	0.550	0.750	0.022	0.030
L	0.300	0.500	0.012	0.020
L1	0.180	0.480	0.007	0.019
L2	0.000	0.100	0.000	0.004
L3	0.000	0.100	0.000	0.004
H	0.315	0.515	0.012	0.020
θ	0°	12°	0°	12°