



Product Summary

$V_{(BR)DSS}$	$R_{DS(on)TYP}$	I_D
50V	0.8Ω@10V	0.34A
	0.85Ω@4.5V	

Feature

- High density cell design for extremely low $R_{DS(on)}$
- Rugged and Reliable

Application

- Direct Logic-Level Interface: TTL/CMOS
- Drivers: Relays, Solenoids, Lamps, Hammers, Display, Memories, Transistors, etc
- Battery Operated Systems
- Solid-State Relays

MARKING:

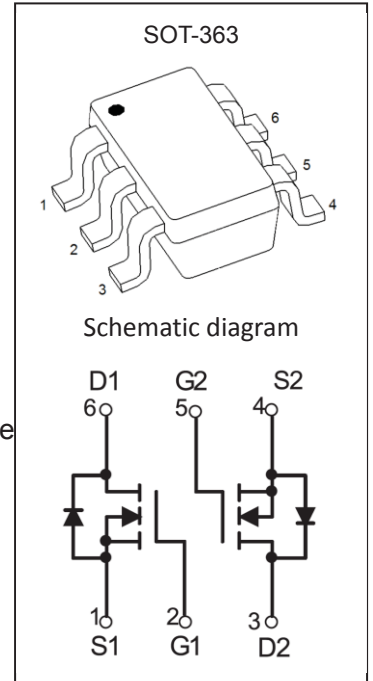
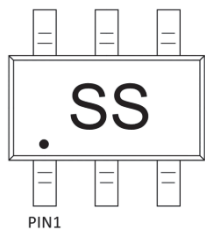

ABSOLUTE MAXIMUM RATINGS ($T_a=25^{\circ}C$ unless otherwise noted)

Parameter	Symbol	Value	Unit
Drain-Source Voltage	V_{DS}	50	V
Gate-Source Voltage	V_{GS}	±20	V
Continuous Drain Current	I_D	0.34	A
Power Dissipation	P_D	150	mW
Thermal Resistance from Junction to Ambient	$R_{\theta JA}$	833	$^{\circ}C/W$
Junction Temperature	T_J	150	$^{\circ}C$
Storage Temperature	T_{STG}	-55~ +150	$^{\circ}C$

MOSFET ELECTRICAL CHARACTERISTICS ($T_a=25^\circ\text{C}$ unless otherwise noted)

Parameter	Symbol	Test Condition	Min	Type	Max	Unit
Static Characteristics						
Drain-source breakdown voltage	$V_{(BR)DSS}$	$V_{GS} = 0V, I_D = 250\mu A$	50			V
Zero gate voltage drain current	I_{DSS}	$V_{DS} = 50V, V_{GS} = 0V$			0.5	μA
Gate-body leakage current	I_{GSS}	$V_{GS} = \pm 20V, V_{DS} = 0V$			± 100	nA
Gate threshold voltage ¹	$V_{GS(th)}$	$V_{DS} = V_{GS}, I_D = 1mA$	0.8	1.1	1.5	V
Drain-source on-resistance ¹	$R_{DS(on)}$	$V_{GS} = 10V, I_D = 220mA$		0.8	2.5	Ω
		$V_{GS} = 4.5V, I_D = 220mA$		0.85	3.0	
Forward transconductance ¹	g_{FS}	$V_{DS} = 10V, I_D = 220mA$		0.15		S
Dynamic characteristics²						
Input Capacitance	C_{iss}	$V_{DS} = 25V, V_{GS} = 0V, f = 1MHz$		26.5		pF
Output Capacitance	C_{oss}			12.9		
Reverse Transfer Capacitance	C_{rss}			5.9		
Switching Characteristics^{1,2}						
Turn-on delay time	$t_{d(on)}$	$V_{DD} = 30V, I_D = 290mA,$ $V_{GS} = 10V, R_G = 6\Omega$			5	nS
Turn-on rise time	t_r				18	
Turn-off delay time	$t_{d(off)}$				36	
Turn-off fall time	t_f				14	
Source-Drain Diode characteristics¹						
Diode Forward voltage	V_{DS}	$I_S = 440mA, V_{GS} = 0V$			1.4	V

Notes:

1. Pulse Test ; Pulse Width $\leq 300\mu s$, Duty Cycle $\leq 2\%$.
2. These parameters have no way to verify.

Typical Electrical and Thermal Characteristics

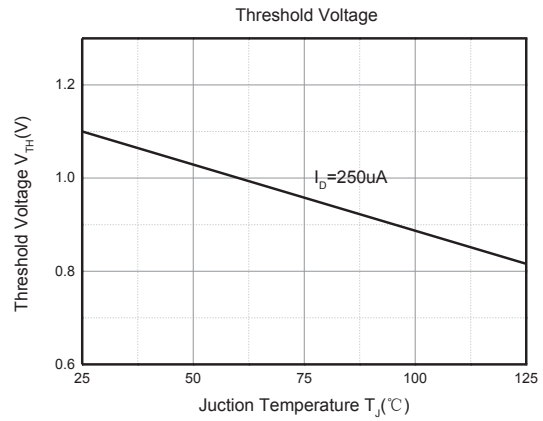
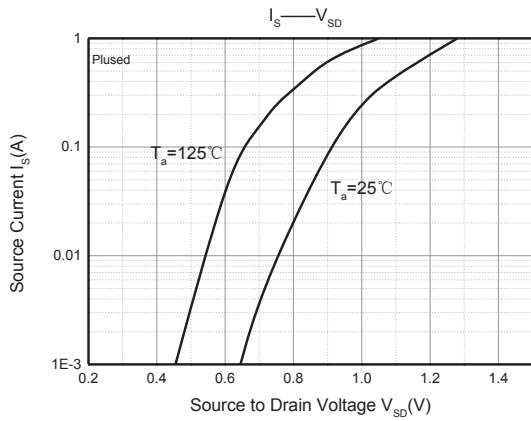
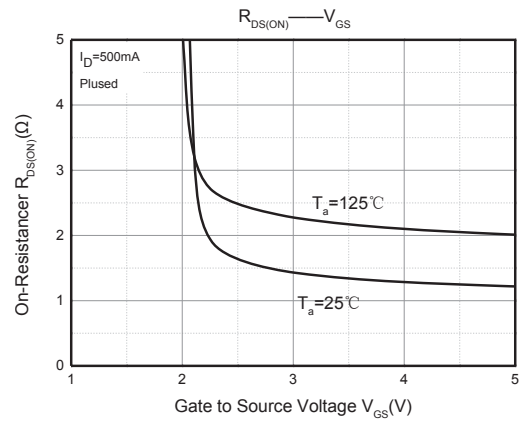
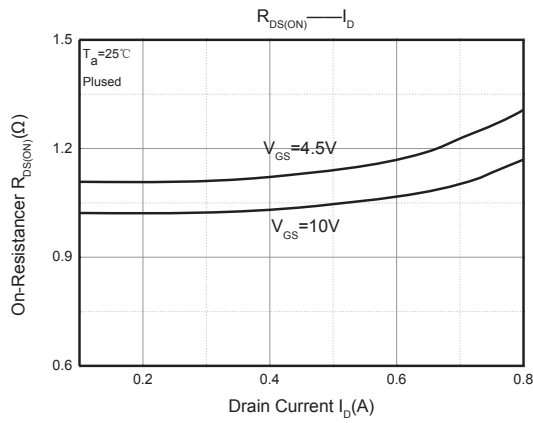
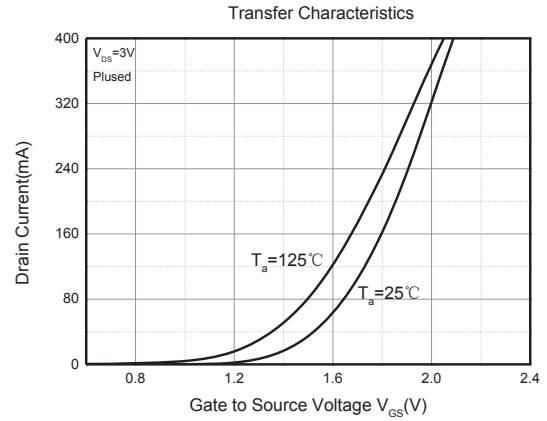
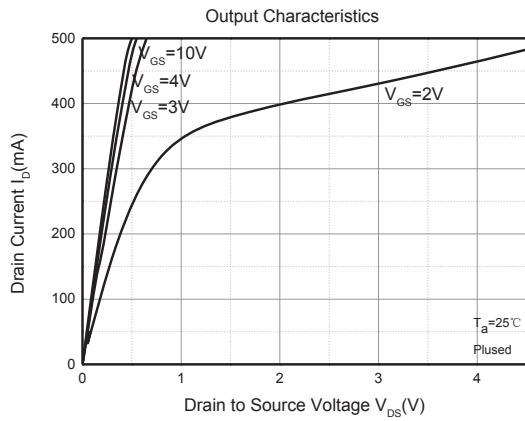

SOT-363 Package Information

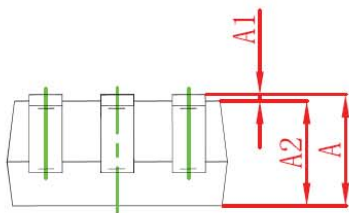
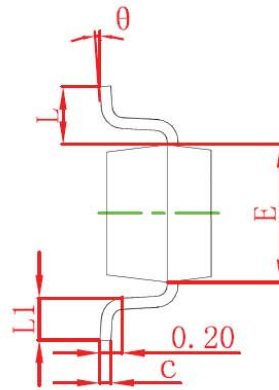
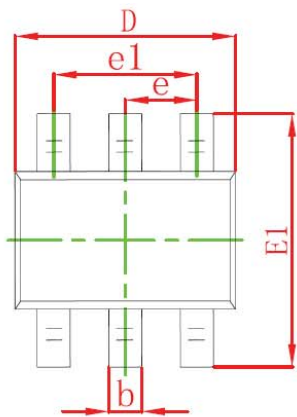

Symbol	Dimensions In Millimeters		Dimensions In Inches	
	Min	Max	Min	Max
A	0.900	1.100	0.035	0.043
A1	0.000	0.100	0.000	0.004
A2	0.900	1.000	0.035	0.039
b	0.150	0.350	0.006	0.014
c	0.100	0.150	0.004	0.006
D	2.000	2.200	0.079	0.087
E	1.150	1.350	0.045	0.053
E1	2.150	2.400	0.085	0.094
e	0.650 TYP		0.026 TYP	
e1	1.200	1.400	0.047	0.055
L	0.525 REF		0.021 REF	
L1	0.260	0.460	0.010	0.018
θ	0°	8°	0°	8°

SOT-363 Tape and Reel

SOT-363 Tape and reel

SOT-363 Embossed Carrier Tape

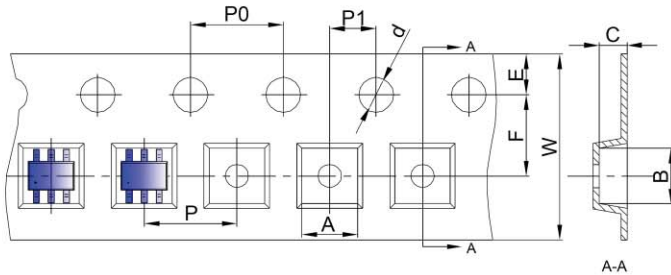

Dimensions are in millimeter										
Pkg type	A	B	C	d	E	F	P0	P	P1	W
SOT-363	2.25	2.55	1.20	Ø1.50	1.75	3.50	4.00	4.00	2.00	8.00

SOT-363 Tape Leader and Trailer

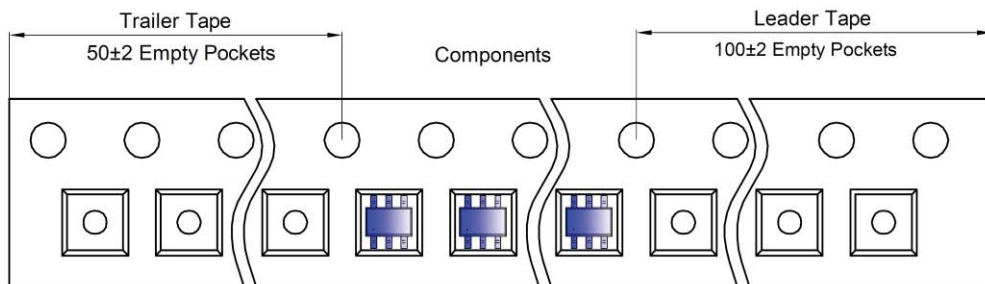

SOT-363 Reel

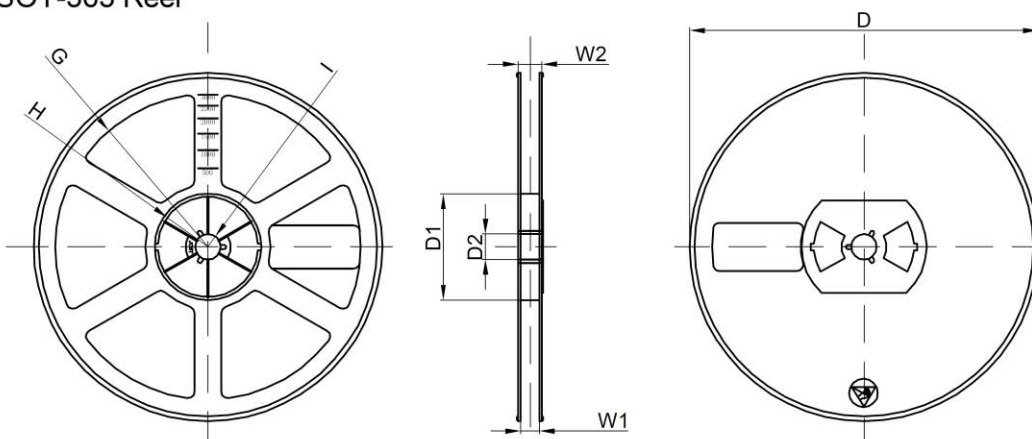

Dimensions are in millimeter								
Reel Option	D	D1	D2	G	H	I	W1	W2
7" Dia	Ø178.00	54.40	13.00	R78.00	R25.60	R6.50	9.50	12.30

REEL	Reel Size	Box	Box Size(mm)	Carton	Carton Size(mm)	G.W.(kg)
3000 pcs	7 inch	30,000 pcs	203×203×195	120,000 pcs	438×438×220	