



Product Summary

$V_{(BR)DSS}$	$R_{DS(on)TYP}$	I_D
50V	1.6Ω@10V	0.34A
	1.8Ω@4.5V	

Feature

- Trench Technology Power MOSFET
- Low $R_{DS(ON)}$
- Low Gate Charge
- ESD Protected

Application

- Load Switch
- DC/DC Converter

MARKING

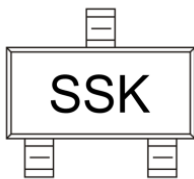

SOT-23

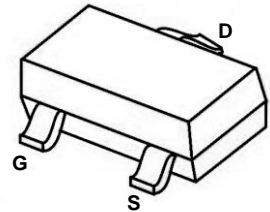

Schematic diagram

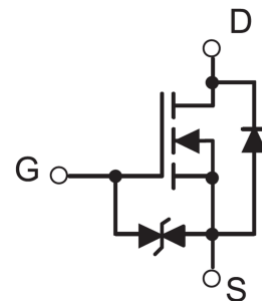

ABSOLUTE MAXIMUM RATINGS ($T_A = 25^\circ\text{C}$ unless otherwise noted)

Parameter	Symbol	Value	Unit
Drain - Source Voltage	V_{DS}	50	V
Gate - Source Voltage	V_{GS}	±20	V
Continuous Drain Current ^{1,4}	I_D	0.34	A
Pulsed Drain Current ²	I_{DM}	1.36	A
Power Dissipation ^{4,5}	P_D	0.35	W
Thermal Resistance from Junction to Ambient ⁵	$R_{\theta JA}$	357	°C/W
Junction Temperature	T_J	150	°C
Storage Temperature	T_{STG}	-55~ +150	°C

MOSFET ELECTRICAL CHARACTERISTICS ($T_J = 25^\circ\text{C}$ unless otherwise noted)

Parameter	Symbol	Test Condition	Min	Type	Max	Unit
Off Characteristics						
Drain - Source Breakdown Voltage	$V_{(BR)DSS}$	$V_{GS} = 0V, I_D = 250\mu A$	50			V
Zero Gate Voltage Drain Current	I_{DSS}	$V_{DS} = 50V, V_{GS} = 0V$			1	μA
Gate - Body Leakage Current	I_{GSS}	$V_{GS} = \pm 20V, V_{DS} = 0V$			± 5	μA
On Characteristics³						
Gate Threshold Voltage	$V_{GS(th)}$	$V_{DS} = V_{GS}, I_D = 250\mu A$	0.8	1.1	1.5	V
Drain-source On-resistance	$R_{DS(on)}$	$V_{GS} = 10V, I_D = 0.1A$		1.6	3.5	Ω
		$V_{GS} = 4.5V, I_D = 0.1A$		1.8	6	
Dynamic Characteristics						
Input Capacitance	C_{iss}	$V_{DS} = 25V, V_{GS} = 0V, f = 1MHz$		18		pF
Output Capacitance	C_{oss}			1		
Reverse Transfer Capacitance	C_{rss}			0.4		
Gate Resistance	R_g	$V_{DS} = 0V, V_{GS} = 0V, f = 1MHz$		43		Ω
Switching Characteristics						
Total Gate Charge	Q_g	$V_{DS} = 25V, V_{GS} = 10V, I_D = 1A$		1.8		nC
Gate-source Charge	Q_{gs}			0.4		
Gate-drain Charge	Q_{gd}			0.7		
Turn-on Delay Time	$t_{d(on)}$	$V_{DD} = 30V, V_{GS} = 10V, I_D = 0.29A,$ $R_G = 3\Omega$			5	ns
Turn-on Rise Time	t_r				18	
Turn-off Delay Time	$t_{d(off)}$				36	
Turn-off Fall Time	t_f				14	
Source - Drain Diode Characteristics						
Diode Forward Voltage ³	V_{SD}	$V_{GS} = 0V, I_S = 0.1A$			1.2	V

Notes :

- 1.The maximum current rating is limited by package.
- 2.Pulse Test : Pulse Width $\leq 10\mu s$, duty cycle $\leq 1\%$.
- 3.Pulse Test : Pulse Width $\leq 300\mu s$, duty cycle $\leq 2\%$.
- 4.The power dissipation P_D is limited by $T_{J(MAX)} = 150^\circ\text{C}$.
- 5.Device mounted on $1in^2$ FR-4 board with 2oz. Copper, in a still air environment with $T_A = 25^\circ\text{C}$.

Typical Characteristics

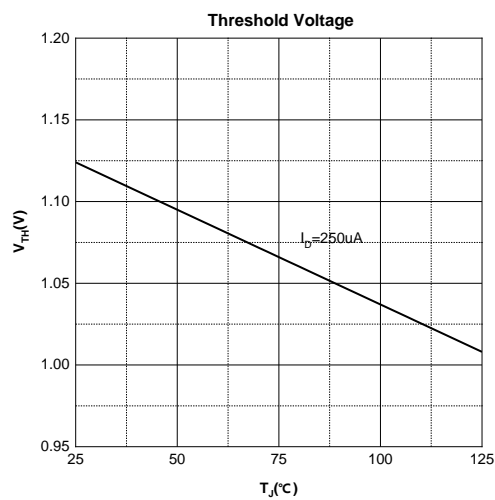
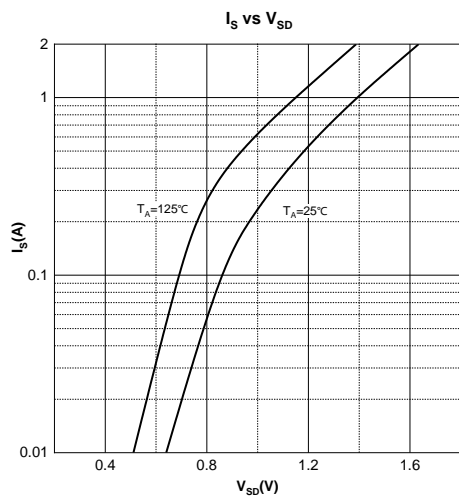
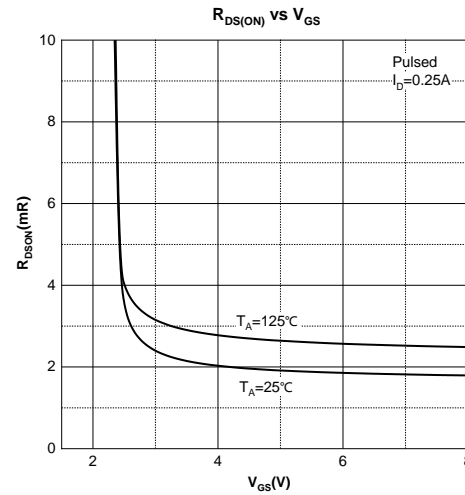
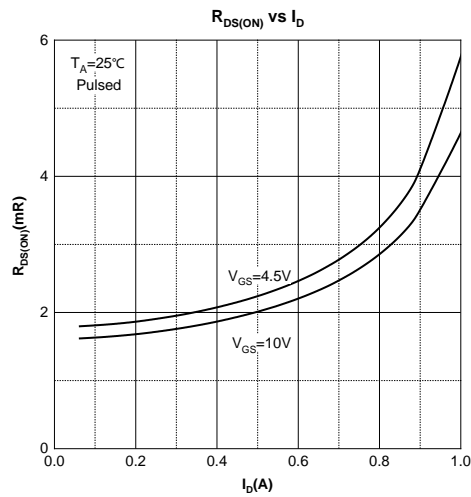
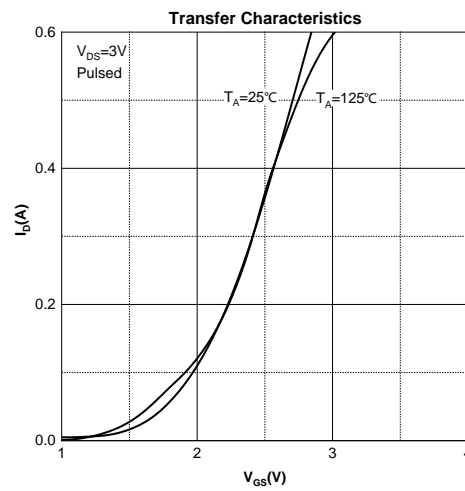
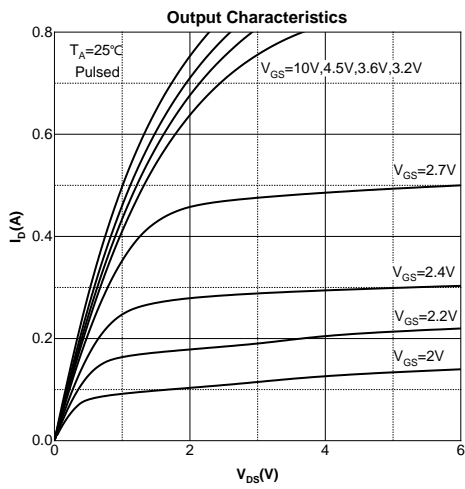

SOT-23 Package Information

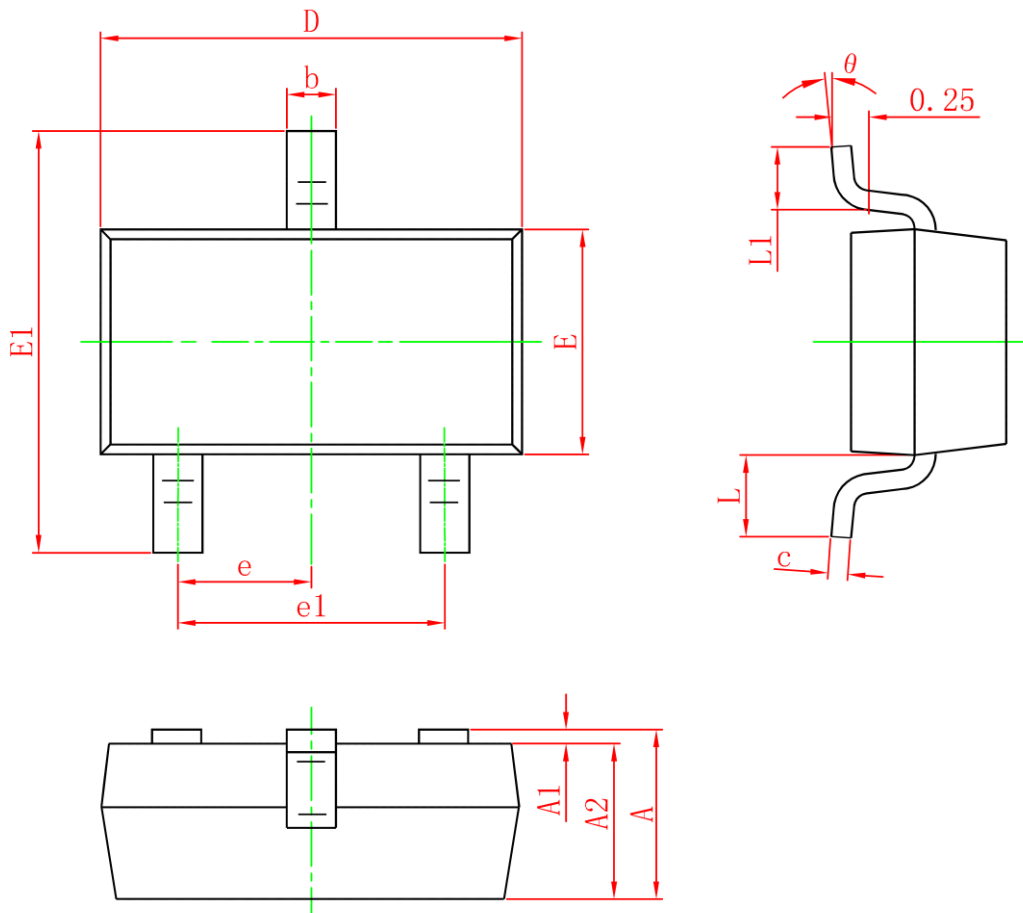

Symbol	Dimensions In Millimeters		Dimensions In Inches	
	Min.	Max.	Min.	Max.
A	0.900	1.150	0.035	0.045
A1	0	0.100	0	0.004
A2	0.900	1.050	0.035	0.041
b	0.300	0.500	0.012	0.020
c	0.080	0.150	0.003	0.006
D	2.800	3.000	0.110	0.118
E	1.150	1.500	0.045	0.059
E1	2.250	2.650	0.089	0.104
e	0.950TYP		0.037TYP	
e1	1.800	2.000	0.071	0.079
L	0.550REF		0.022REF	
L1	0.300	0.500	0.012	0.020
θ	0°	8°	0°	8°