



### Product Summary

V <sub>(BR)DSS</sub>	R <sub>DS(on)TYP</sub>	I <sub>D</sub>
-20V	400mΩ@-4.5V	-0.66A
	570mΩ@-2.5V	
	810mΩ@-1.8V	

### Feature

- Trench Technology Power MOSFET
- Low R<sub>DS(ON)</sub>
- Low Gate Charge
- ESD Protected

### Application

- Load Switching
- Low Current Inverters
- Low Current DC/DC Converters

### MARKING:

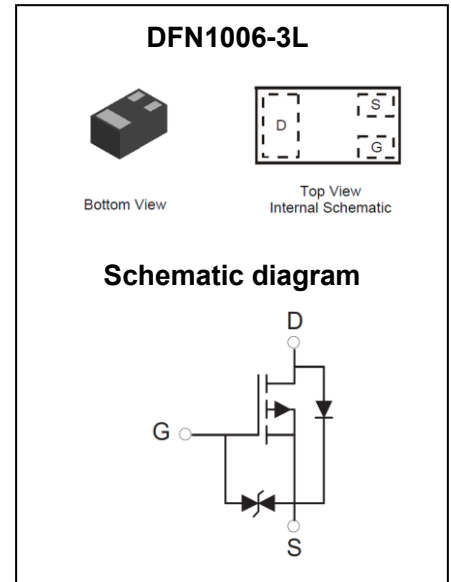

### ABSOLUTE MAXIMUM RATINGS (T<sub>A</sub> = 25°C unless otherwise noted)

Parameter	Symbol	Value	Unit
Drain - Source Voltage	V <sub>DS</sub>	-20	V
Gate - Source Voltage	V <sub>GS</sub>	±12	V
Continuous Drain Current <sup>1,5</sup>	I <sub>D</sub>	-0.66	A
Pulsed Drain Current <sup>2</sup>	I <sub>DM</sub>	-2.0	A
Power Dissipation <sup>4,5</sup>	P <sub>D</sub>	0.3	W
Thermal Resistance from Junction to Ambient <sup>5</sup>	R <sub>θJA</sub>	416	°C/W
Junction Temperature	T <sub>J</sub>	150	°C
Storage Temperature	T <sub>STG</sub>	-55~ +150	°C

**MOSFET ELECTRICAL CHARACTERISTICS ( $T_J = 25^\circ\text{C}$  unless otherwise noted)**

Parameter	Symbol	Test Condition	Min	Type	Max	Unit
<b>Off Characteristics</b>						
Drain - Source Breakdown Voltage	$V_{(BR)DSS}$	$V_{GS} = 0V, I_D = -250\mu A$	-20			V
Zero Gate Voltage Drain Current	$I_{DSS}$	$V_{DS} = -16V, V_{GS} = 0V$			-1	$\mu A$
Gate - Body Leakage Current	$I_{GSS}$	$V_{GS} = \pm 10V, V_{DS} = 0V$			$\pm 10$	$\mu A$
<b>On Characteristics<sup>3</sup></b>						
Gate Threshold Voltage	$V_{GS(th)}$	$V_{DS} = V_{GS}, I_D = -250\mu A$	-0.4	-0.7	-1.0	V
Drain-source On-resistance	$R_{DS(on)}$	$V_{GS} = -4.5V, I_D = -0.5A$		400	520	m $\Omega$
		$V_{GS} = -2.5V, I_D = -0.3A$		570	780	
		$V_{GS} = -1.8V, I_D = -0.12A$		810	1100	
Forward Transconductance	$g_{FS}$	$V_{DS} = -5V, I_D = -0.4A$		1		S
<b>Dynamic Characteristics</b>						
Input Capacitance	$C_{iss}$	$V_{DS} = -10V, V_{GS} = 0V, f = 1MHz$		79		pF
Output Capacitance	$C_{oss}$			15		
Reverse Transfer Capacitance	$C_{rss}$			13		
<b>Switching Characteristics</b>						
Total Gate Charge	$Q_g$	$V_{DS} = -10V, V_{GS} = -4.5V, I_D = -0.2A$		2.26		nC
Gate-source Charge	$Q_{gs}$			0.45		
Gate-drain Charge	$Q_{gd}$			0.24		
Turn-on Delay Time	$t_{d(on)}$	$V_{DD} = -10V, V_{GS} = -4.5V,$ $R_L = 50\Omega, R_G = 3\Omega$		8		ns
Turn-on Rise Time	$t_r$			5.5		
Turn-off Delay Time	$t_{d(off)}$			30		
Turn-off Fall Time	$t_f$			17		
<b>Source - Drain Diode Characteristics</b>						
Diode Forward Voltage <sup>3</sup>	$V_{SD}$	$V_{GS} = 0V, I_S = -0.5A$			-1.2	V

Notes :

- 1.The maximum current rating is limited by package.
- 2.Repetitive rating;pulse width limited by  $T_J(MAX) = 150^\circ\text{C}$ .
- 3.Pulse Test : Pulse Width  $\leq 300\mu s$ , duty cycle  $\leq 2\%$ .
- 4.The power dissipation PD is limited by  $T_J(MAX) = 150^\circ\text{C}$ .
- 5.Device mounted on 1in2 FR-4 board with 2oz. Copper, in a still air environment with  $T_A = 25^\circ\text{C}$ .

**Typical Characteristics**

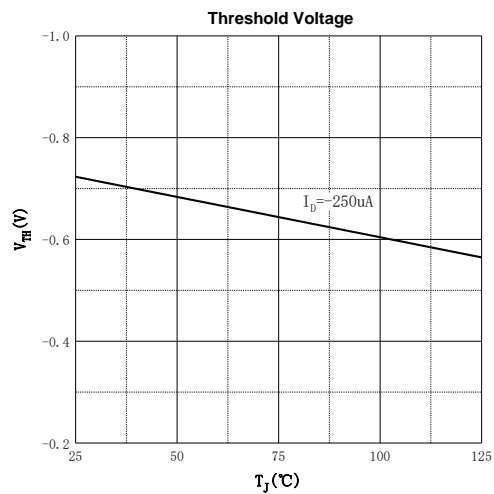
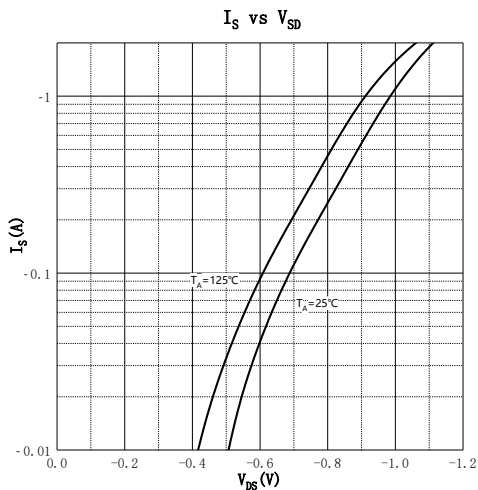
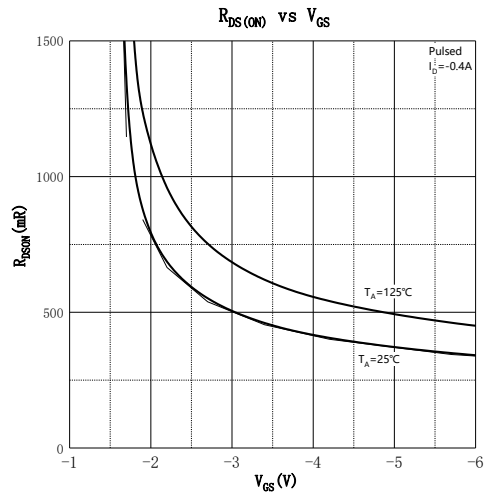
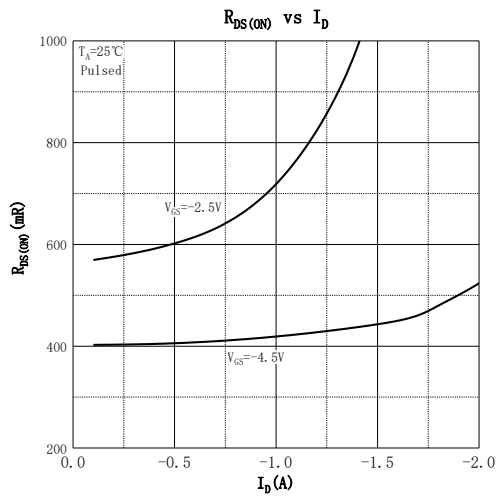
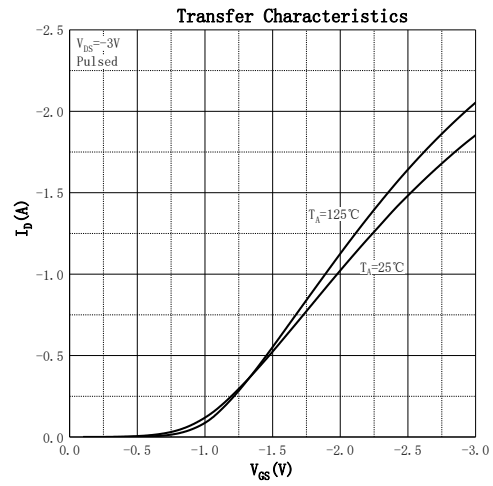
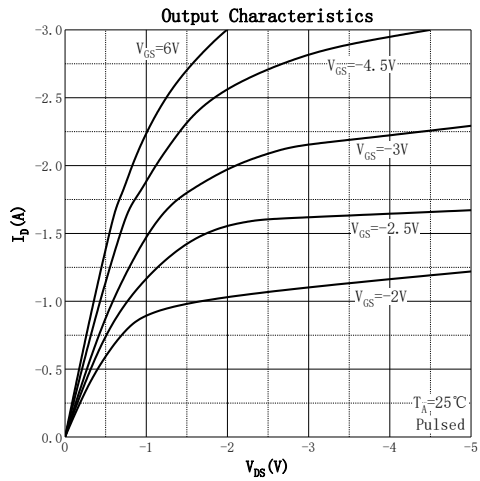

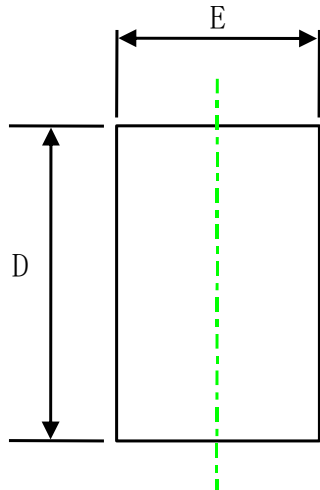
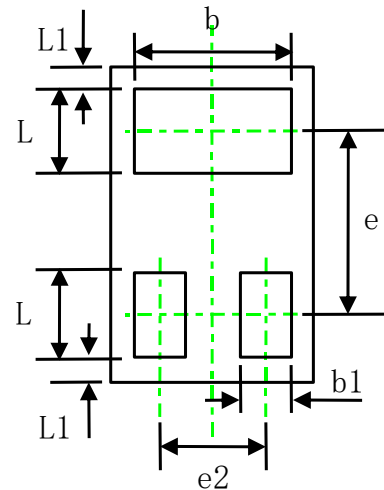
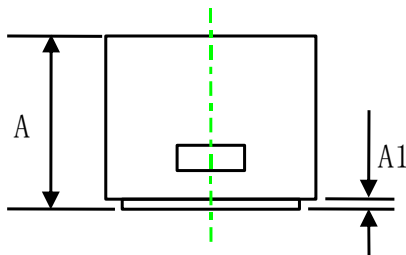
**DFN1006-3L Package Information**

 TOP VIEW  
 [顶视图]

 BOTTOM VIEW  
 [底视图]

 SIDE VIEW  
 [侧视图]

Symbol	Dimensions In Millimeters		Dimensions In Inches	
	Min.	Max.	Min.	Max.
A	0.340	0.400	0.013	0.016
A1	0.000	0.050	0.000	0.002
D	0.950	1.050	0.037	0.041
E	0.550	0.650	0.022	0.026
b	0.400	0.600	0.016	0.024
e	0.65 TYP		0.026 TYP	
e2	0.35 TYP		0.014 TYP	
L1	0.05 REF		0.002 REF	
L	0.200	0.300	0.008	0.012
b1	0.100	0.200	0.004	0.008