



Product Summary

$V_{(BR)DSS}$	$R_{DS(on)TYP}$	I_D
40V	2.0m Ω @10V	160A
	2.5m Ω @4.5V	

Feature

- Trench Technology Power MOSFET
- Low $R_{DS(ON)}$
- Low Gate Charge
- Low Gate Resistance
- 100% UIS Tested

Application

- Power Switching Application

MARKING:



M033N04L = Device Code
 XX = Date Code
 Solid Dot = Green Indicator

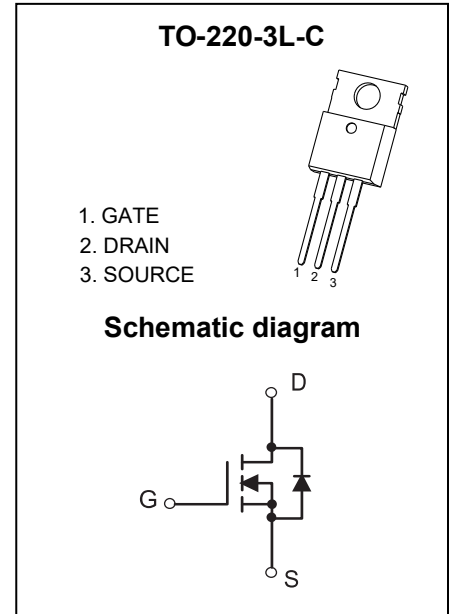

ABSOLUTE MAXIMUM RATINGS ($T_A = 25^\circ\text{C}$ unless otherwise noted)

Parameter	Symbol	Value	Unit
Drain - Source Voltage	V_{DS}	40	V
Gate - Source Voltage	V_{GS}	± 20	V
Continuous Drain Current ¹	$T_C = 25^\circ\text{C}$	I_D	160 A
	$T_C = 100^\circ\text{C}$	I_D	104 A
Pulsed Drain Current ²	I_{DM}	640	A
Single Pulsed Avalanche Current ³	I_{AS}	60	A
Single Pulsed Avalanche Energy ³	E_{AS}	900	mJ
Power Dissipation ⁵	$T_C = 25^\circ\text{C}$	P_D	145 W
Thermal Resistance from Junction to Ambient ⁶	$R_{\theta JA}$	60	$^\circ\text{C}/\text{W}$
Thermal Resistance from Junction to Case	$R_{\theta JC}$	0.86	$^\circ\text{C}/\text{W}$
Junction Temperature	T_J	150	$^\circ\text{C}$
Storage Temperature	T_{STG}	-55~ +150	$^\circ\text{C}$

MOSFET ELECTRICAL CHARACTERISTICS ($T_J = 25^\circ\text{C}$ unless otherwise noted)

Parameter	Symbol	Test Condition	Min	Type	Max	Unit
Off Characteristics						
Drain - Source Breakdown Voltage	$V_{(BR)DSS}$	$V_{GS} = 0V, I_D = 250\mu A$	40			V
Zero Gate Voltage Drain Current	I_{DSS}	$V_{DS} = 32V, V_{GS} = 0V$			1	μA
Gate - Body Leakage Current	I_{GSS}	$V_{GS} = \pm 20V, V_{DS} = 0V$			± 100	nA
On Characteristics⁴						
Gate Threshold Voltage	$V_{GS(th)}$	$V_{DS} = V_{GS}, I_D = 250\mu A$	1	1.8	3	V
Drain-source On-resistance	$R_{DS(on)}$	$V_{GS} = 10V, I_D = 20A$		2.0	3.3	m Ω
		$V_{GS} = 4.5V, I_D = 20A$		2.5	4.0	
Dynamic Characteristics						
Input Capacitance	C_{iss}	$V_{DS} = 20V, V_{GS} = 0V, f = 0.1MHz$		12444		pF
Output Capacitance	C_{oss}			786		
Reverse Transfer Capacitance	C_{rss}			685		
Gate Resistance	R_g	$V_{DS} = 0V, V_{GS} = 0V, f = 1MHz$		1.1		Ω
Switching Characteristics						
Total Gate Charge	Q_g	$V_{DS} = 20V, V_{GS} = 10V, I_D = 25A$		215		nC
Gate-source Charge	Q_{gs}			33		
Gate-drain Charge	Q_{gd}			38		
Turn-on Delay Time	$t_{d(on)}$	$V_{DD} = 30V, V_{GS} = 10V, R_L = 15\Omega, R_G = 2.5\Omega$		42		ns
Turn-on Rise Time	t_r			41		
Turn-off Delay Time	$t_{d(off)}$			147		
Turn-off Fall Time	t_f			66		
Source - Drain Diode Characteristics						
Diode Forward Voltage ⁴	V_{SD}	$V_{GS} = 0V, I_S = 10A$			1.2	V

Notes :

- 1.The maximum current rating is limited by package.And device mounted on a large heatsink
- 2.Pulse Test : Pulse Width $\leq 10\mu s$, duty cycle $\leq 1\%$.
- 3.EAS condition: $V_{DD} = 35V, V_{GS} = 10V, L = 0.5mH, R_G = 25\Omega$ Starting $T_J = 25^\circ\text{C}$.
- 4.Pulse Test : Pulse Width $\leq 300\mu s$, duty cycle $\leq 2\%$.
- 5.The power dissipation P_D is limited by $T_{J(MAX)} = 150^\circ\text{C}$.And device mounted on a large heatsink
- 6.Device mounted on $1in^2$ FR-4 board with 2oz. Copper, in a still air environment with $T_A = 25^\circ\text{C}$.

Typical Characteristics

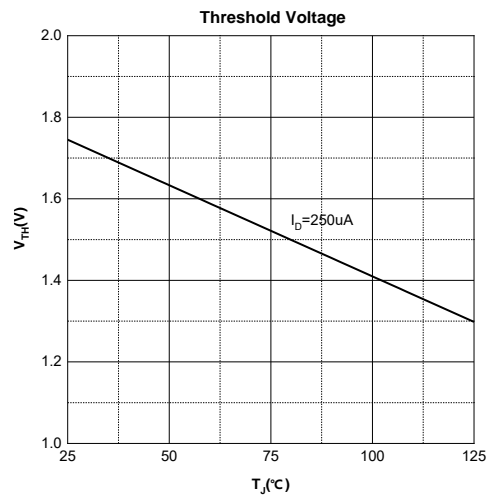
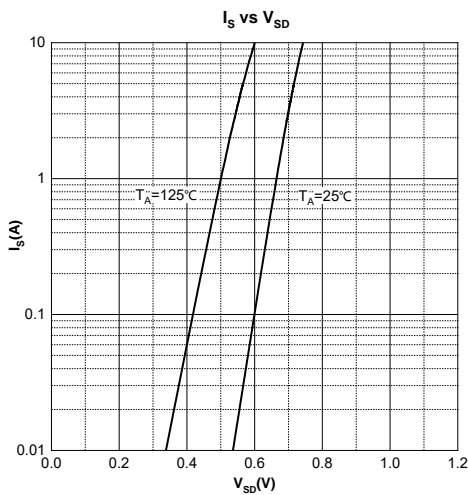
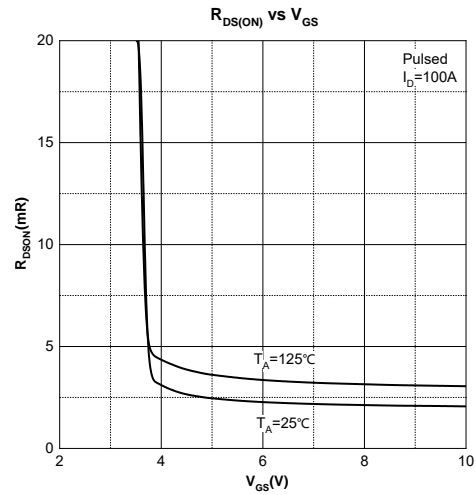
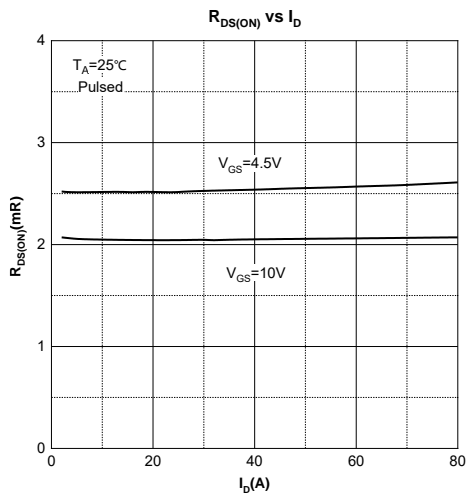
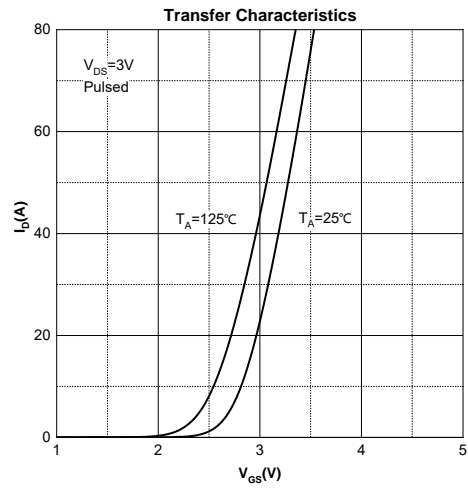
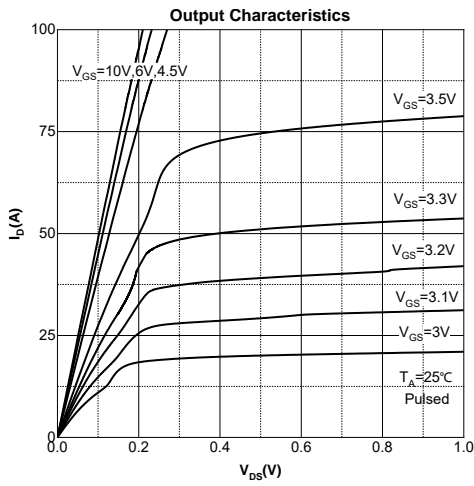

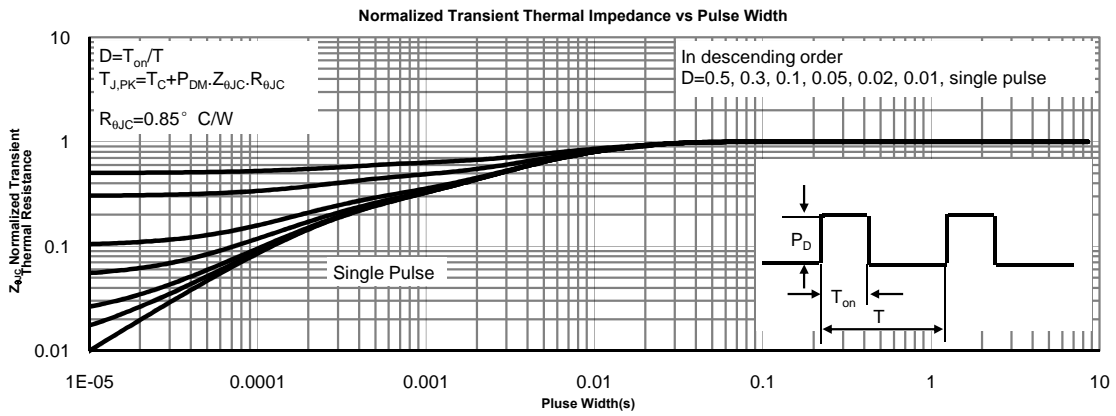
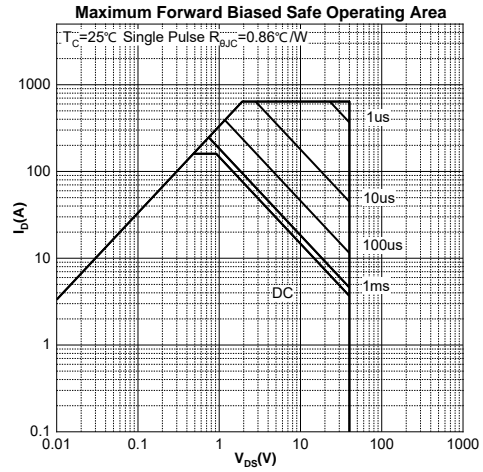
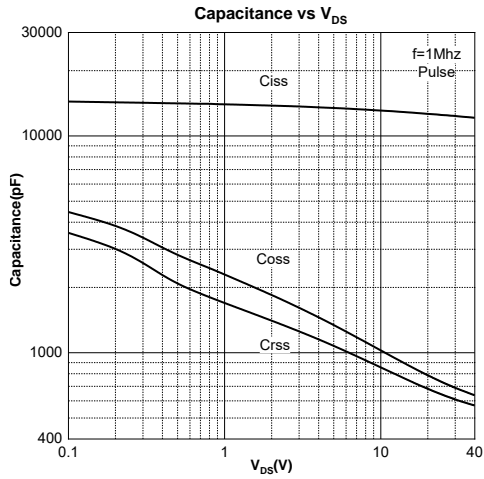

TO-220-3L-C Package Information

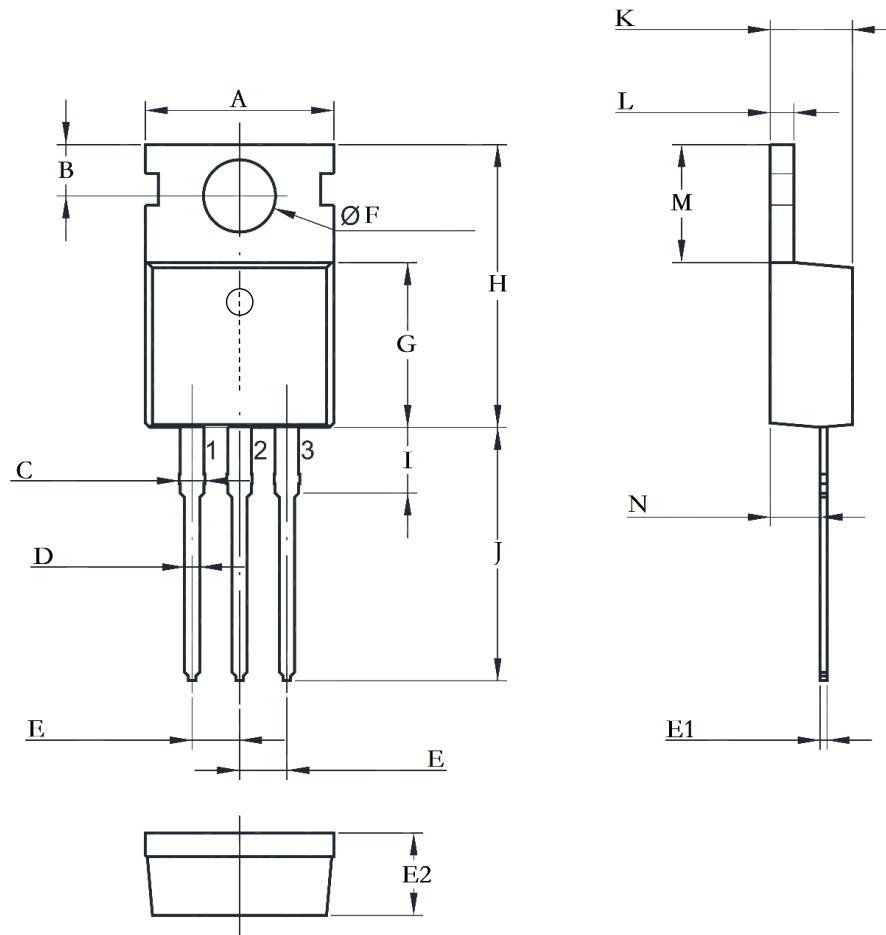

Symbol	Dimensions In Millimeters		Dimensions In Inches	
	Min.	Max.	Min.	Max.
A	9.600	10.400	0.378	0.409
B	2.800TYP		0.110TYP	
C	1.200	1.600	0.047	0.063
D	0.600	1.000	0.024	0.039
E	2.540TYP		0.100TYP	
E1	0.300	0.700	0.012	0.028
E2	4.300	4.700	0.169	0.185
F	3.400	4.000	0.134	0.157
G	8.850	9.350	0.348	0.368
H	14.600	16.100	0.575	0.634
I	2.800	4.200	0.110	0.165
J	12.600	14.800	0.496	0.583
K	4.300	4.700	0.169	0.185
L	1.000	1.400	0.039	0.055
M	5.840	7.000	0.230	0.276
N	1.800	2.900	0.071	0.114