



Product Summary

$V_{(BR)DSS}$	$R_{DS(on)TYP}$	I_D
-30V	78m Ω @-10V	-2.7A
	89m Ω @-4.5V	
	122m Ω @-2.5V	

Feature

- Trench Technology Power MOSFET
- Low $R_{DS(ON)}$
- Low Gate Charge
- Low Gate Resistance

Application

- Load Switch
- DC/DC Converter

MARKING:

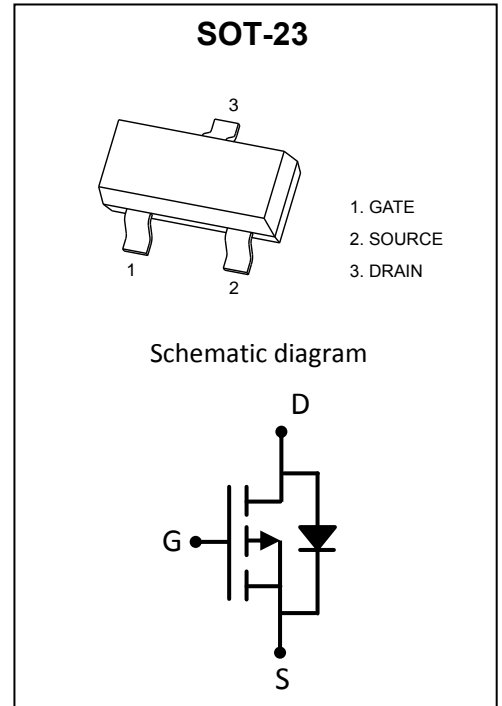
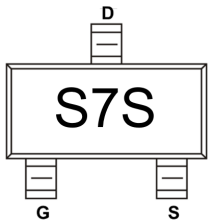

ABSOLUTE MAXIMUM RATINGS ($T_A = 25^\circ\text{C}$ unless otherwise noted)

Parameter	Symbol	Value	Unit
Drain - Source Voltage	V_{DS}	-30	V
Gate - Source Voltage	V_{GS}	± 12	V
Continuous Drain Current ^{1,5}	I_D	-2.7	A
Pulsed Drain Current ²	I_{DM}	-11	A
Power Dissipation ^{4,5}	P_D	1.1	W
Thermal Resistance from Junction to Ambient ⁵	$R_{\theta JA}$	114	$^\circ\text{C}/\text{W}$
Junction Temperature	T_J	150	$^\circ\text{C}$
Storage Temperature	T_{STG}	-55~ +150	$^\circ\text{C}$

MOSFET ELECTRICAL CHARACTERISTICS (T_J = 25°C unless otherwise noted)

Parameter	Symbol	Test Condition	Min	Type	Max	Unit
Off Characteristics						
Drain - Source Breakdown Voltage	V _{(BR)DSS}	V _{GS} = 0V, I _D = -250μA	-30			V
Zero Gate Voltage Drain Current	I _{DSS}	V _{DS} = -30V, V _{GS} = 0V			-1	μA
Gate - Body Leakage Current	I _{GSS}	V _{GS} = ±12V, V _{DS} = 0V			±100	nA
On Characteristics³						
Gate Threshold Voltage	V _{GS(th)}	V _{DS} = V _{GS} , I _D = -250μA	-0.5	-1.0	-1.5	V
Drain-source On-resistance	R _{DS(on)}	V _{GS} = -10V, I _D = -3.5A		78	90	mΩ
		V _{GS} = -4.5V, I _D = -2.5A		89	112	
		V _{GS} = -2.5V, I _D = -2A		122	159	
Dynamic Characteristics						
Input Capacitance	C _{iss}	V _{DS} = -15V, V _{GS} = 0V, f = 1MHz		531		pF
Output Capacitance	C _{oss}			47		
Reverse Transfer Capacitance	C _{rss}			38		
Gate Resistance	R _g	V _{DS} = 0V, V _{GS} = 0V, f = 1MHz		26		Ω
Switching Characteristics						
Total Gate Charge	Q _g	V _{DS} = -15V, V _{GS} = -10V, I _D = -3.5A		12.6		nC
Gate-source Charge	Q _{gs}			1.1		
Gate-drain Charge	Q _{gd}			1.9		
Turn-on Delay Time	t _{d(on)}	V _{DD} = -15V, V _{GS} = -10V, R _G = 3Ω, R _L = 5.76Ω,		15		ns
Turn-on Rise Time	t _r			10		
Turn-off Delay Time	t _{d(off)}			34		
Turn-off Fall Time	t _f			13		
Source - Drain Diode Characteristics						
Diode Forward Voltage ³	V _{SD}	V _{GS} = 0V, I _S = -1.5A			-1.2	V

Notes :

- 1.The maximum current rating is limited by package.
- 2.Pulse Test : Pulse Width ≤ 10μs, duty cycle ≤ 1%.
- 3.Pulse Test : Pulse Width ≤ 300μs, duty cycle ≤ 2%.
- 4.The power dissipation P_D is limited by T_{J(MAX)} = 150°C.
- 5.Device mounted on 1in² FR-4 board with 2oz. Copper, in a still air environment with T_A =25°C.

Typical Characteristics

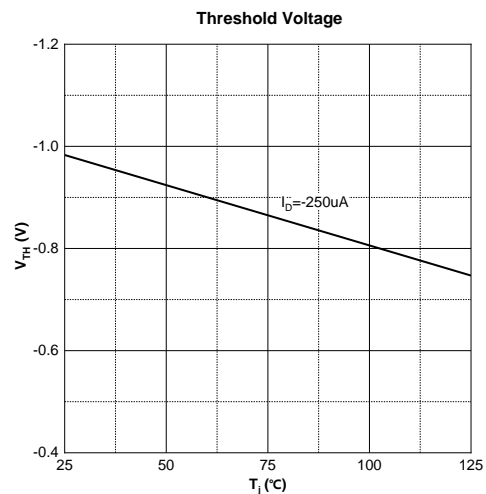
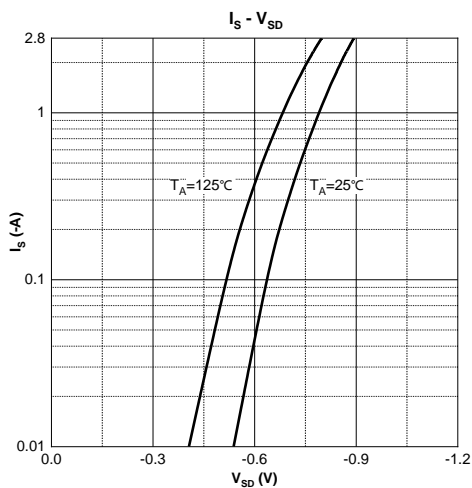
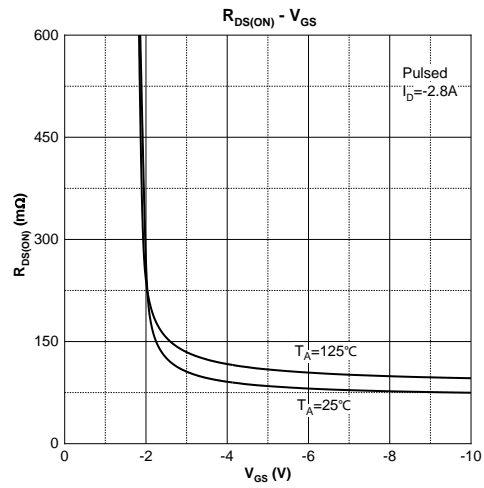
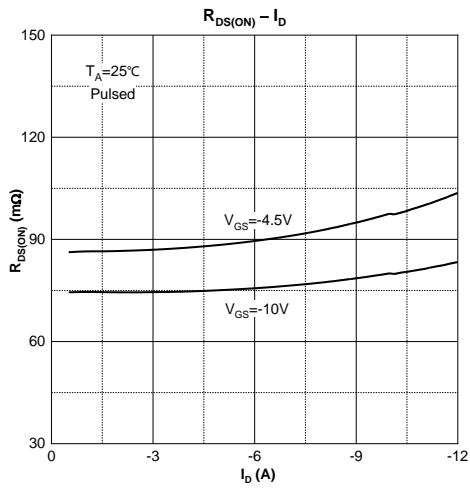
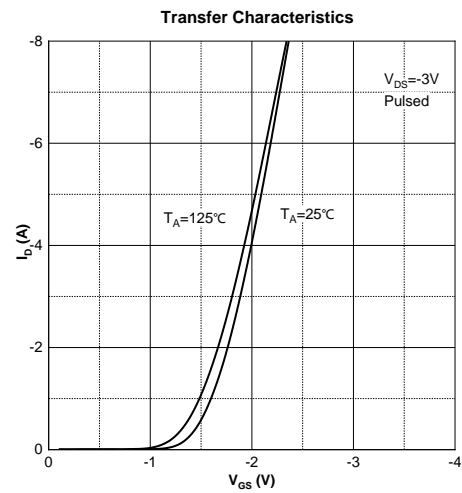
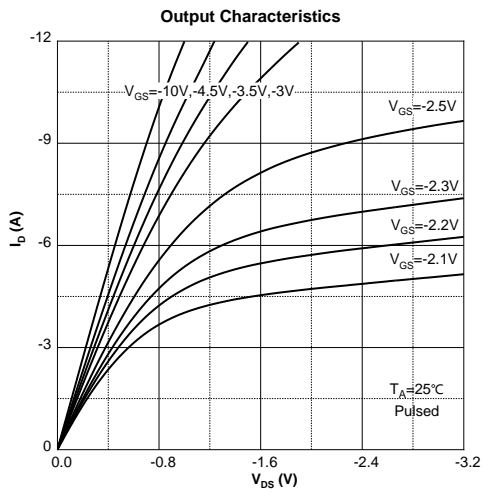

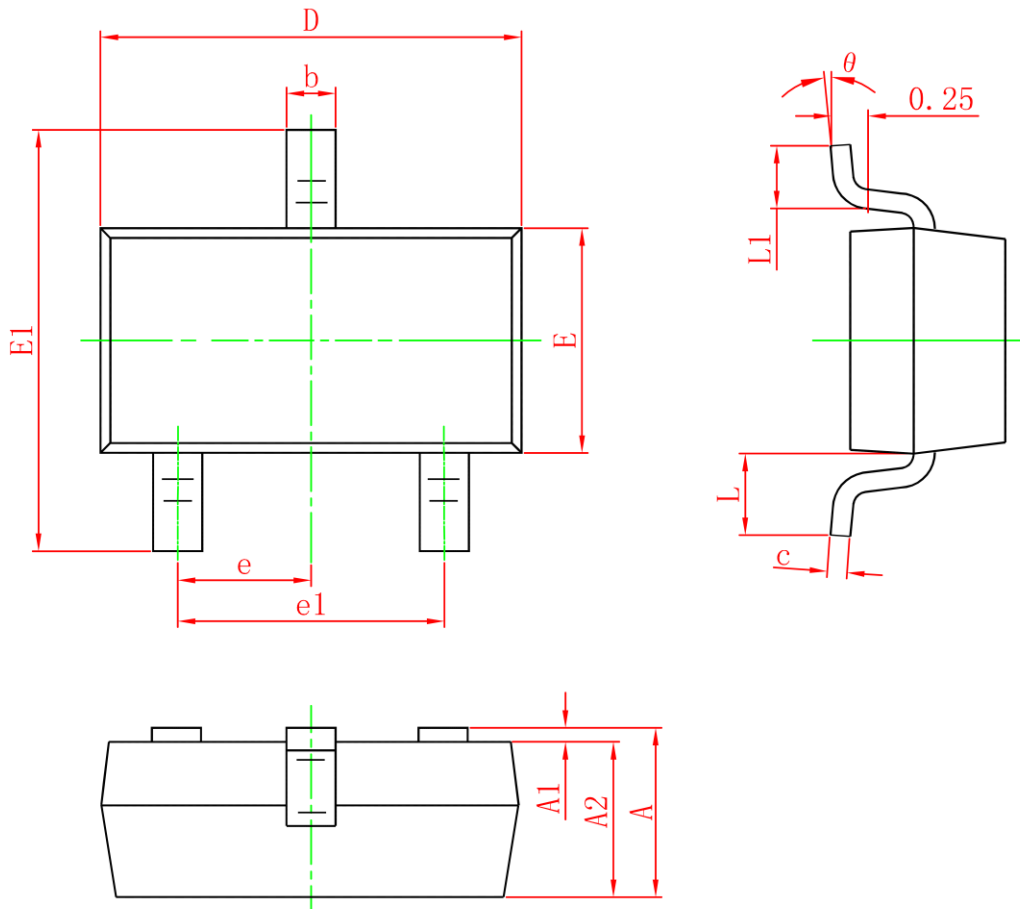
SOT-23 Package Information

Symbol	Dimensions In Millimeters		Dimensions In Inches	
	Min.	Max.	Min.	Max.
A	0.900	1.150	0.035	0.045
A1	0	0.100	0	0.004
A2	0.900	1.050	0.035	0.041
b	0.300	0.500	0.012	0.020
c	0.080	0.150	0.003	0.006
D	2.800	3.000	0.110	0.118
E	1.150	1.500	0.045	0.059
E1	2.250	2.650	0.089	0.104
e	0.950TYP		0.037TYP	
e1	1.800	2.000	0.071	0.079
L	0.550REF		0.022REF	
L1	0.300	0.500	0.012	0.020
θ	0°	8°	0°	8°