

Product Summary

$V_{(BR)DSS}$	$R_{DS(on)TYP}$	I_D
30V	33mΩ@10V	4.0A
	43mΩ@4.5V	

Feature

- TrenchFET Power MOSFET

Application

- Load Switch for Portable Devices
- DC/DC Converter

MARKING:

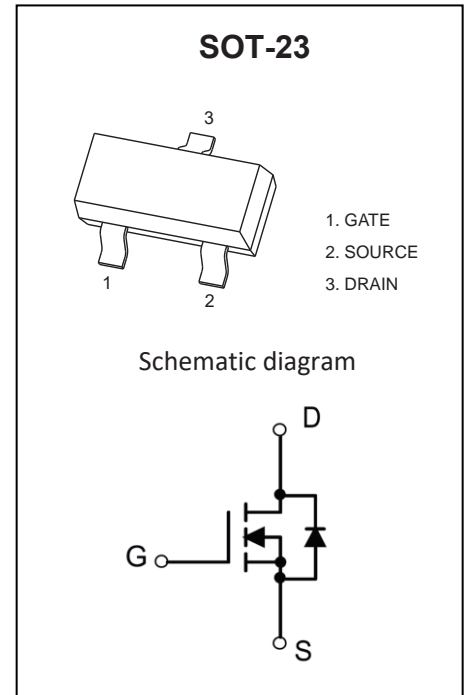
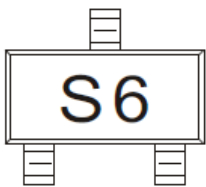

ABSOLUTE MAXIMUM RATINGS ($T_a=25^{\circ}C$ unless otherwise noted)

Parameter	Symbol	Value	Unit
Drain-Source Voltage	V_{DS}	30	V
Gate-Source Voltage	V_{GS}	±20	
Continuous Drain Current($T_J=150^{\circ}C$)	I_D	4.0	A
Pulsed Drain Current	I_{DM}	16	
Continuous Source Current(Diode Conduction)	I_S	4.0	
Maximum Power Dissipation	P_D	0.75	W
Thermal Resistance from Junction to Ambient($t \leq 5s$)	$R_{\theta JA}$	166	$^{\circ}C/W$
Junction Temperature	T_J	150	$^{\circ}C$
Storage Temperature	T_{STG}	-55~ +150	

MOSFET ELECTRICAL CHARACTERISTICS(T_a=25°C unless otherwise noted)

Parameter	Symbol	Test Condition	Min	Type	Max	Unit
Static Characteristics						
Drain-source breakdown voltage	V _{(BR)DSS}	V _{GS} = 0V, I _D =250μA	30			V
Zero gate voltage drain current	I _{DSS}	V _{DS} =30V, V _{GS} = 0V			0.5	μA
Gate-body leakage current	I _{GSS}	V _{GS} =±20V, V _{DS} = 0V			±100	nA
Gate threshold voltage	V _{GS(th)}	V _{DS} =V _{GS} , I _D =250μA	1	1.6	3	V
Drain-source on-resistance ^a	R _{DS(on)}	V _{GS} =10V, I _D =3.5A		33	45	mΩ
		V _{GS} =4.5V, I _D =2.8A		43	57	
Forward tranconductance ^a	g _{FS}	V _{DS} =4.5V, I _D =2.5A		7		S
Dynamic characteristics^b						
gate charge	Q _g	V _{DS} =15V, V _{GS} =5V, I _D =2.5A		3.0	4.5	nC
Total Gate Charge	Q _{gt}	V _{DS} =15V, V _{GS} =10V, I _D =2.5A		6	9	
Gate-source charge	Q _{gs}			1.6		
Gate-drain charge	Q _{gd}			0.6		
Gate resistance	R _g	f =1.0MHz		5	7.5	Ω
Input Capacitance	C _{iss}	V _{DS} =10V, V _{GS} =0V, f =1MHz		238		pF
Output Capacitance	C _{oss}			60		
Reverse Transfer Capacitance	C _{rss}			50		
Turn-on delay time	t _{d(on)}	V _{DD} =15V, R _L =15Ω, I _D ≈1A, V _{GEN} =10V, R _g =6Ω		7	11	ns
Turn-on rise time	t _r			12	18	
Turn-off delay time	t _{d(off)}			14	25	
Turn-off fall time	t _f			6	10	
Source-Drain Diode characteristics						
Body diode voltage	V _{SD}	I _S =1.25A, V _{GS} =0V		0.8	1.2	V

Notes:

- a.Pulse Test : Pulse width≤300μs, duty cycle ≤2%.
b.Guaranteed by design, not subject to production testing.

Typical Characteristics

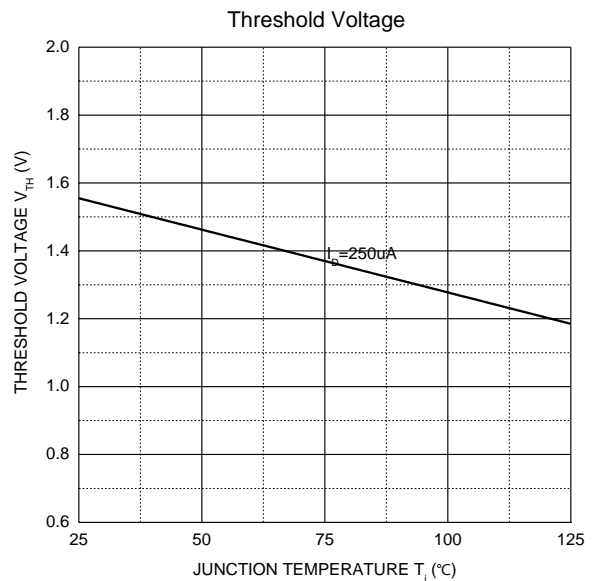
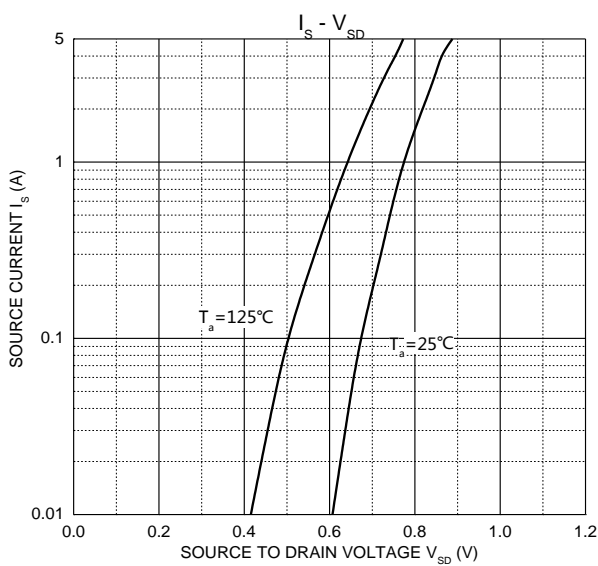
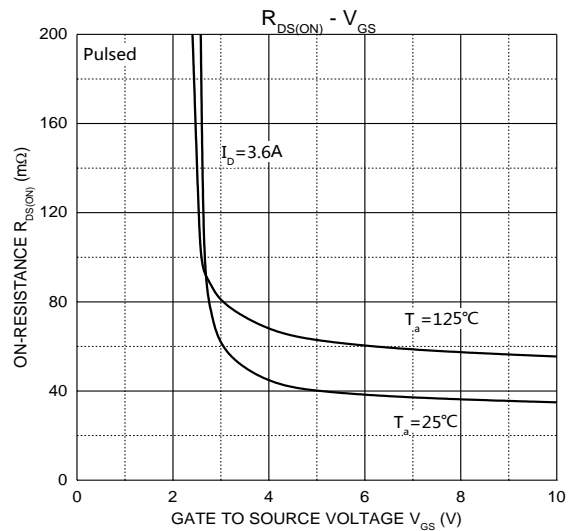
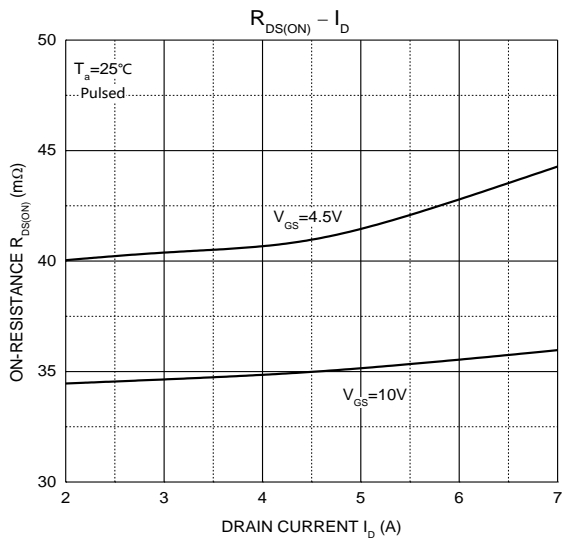
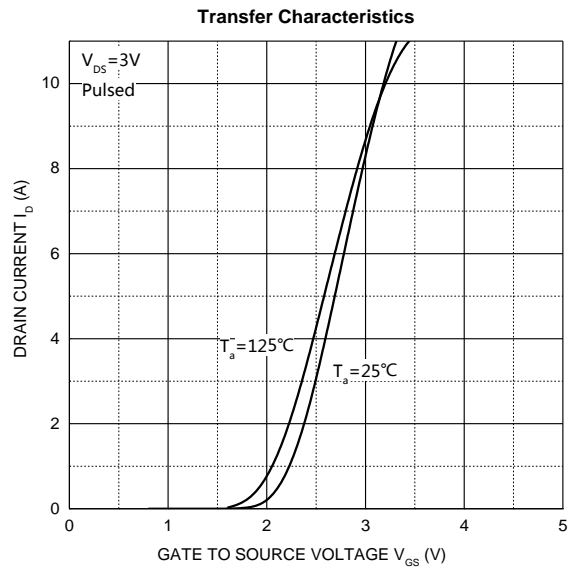
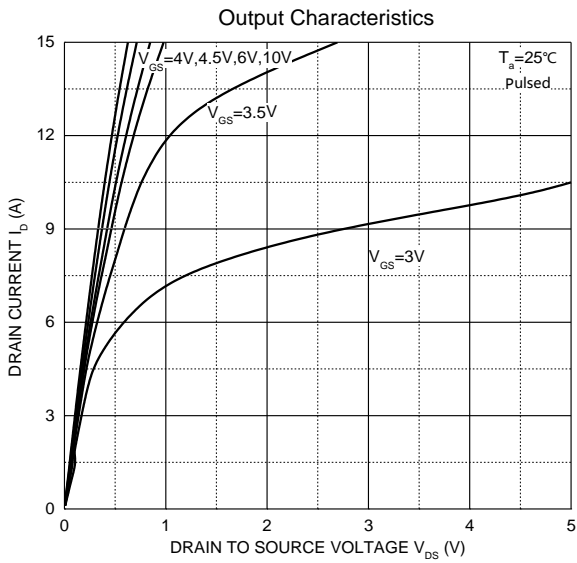

SOT-23 Package Information

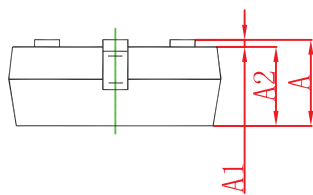
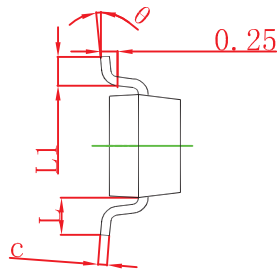
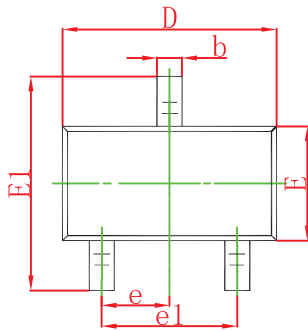

Symbol	Dimensions In Millimeters		Dimensions In Inches	
	Min	Max	Min	Max
A	0.900	1.150	0.035	0.045
A1	0.000	0.100	0.000	0.004
A2	0.900	1.050	0.035	0.041
b	0.300	0.500	0.012	0.020
c	0.080	0.150	0.003	0.006
D	2.800	3.000	0.110	0.118
E	1.200	1.400	0.047	0.055
E1	2.250	2.550	0.089	0.100
e	0.950 TYP		0.037 TYP	
e1	1.800	2.000	0.071	0.079
L	0.550 REF		0.022 REF	
L1	0.300	0.500	0.012	0.020
θ	0°	8°	0°	8°

SOT-23 Tape and Reel

SOT-23 Embossed Carrier Tape

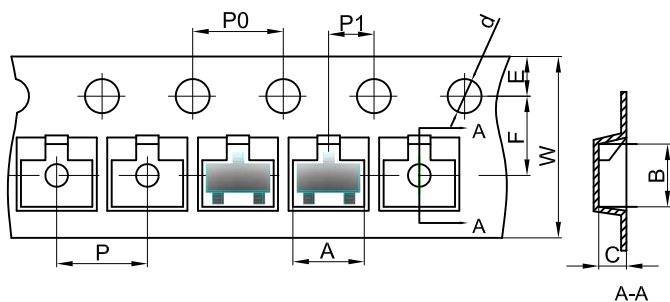

Dimensions are in millimeter										
Pkg type	A	B	C	d	E	F	P0	P	P1	W
SOT-23	3.15	2.77	1.22	Ø1.50	1.75	3.50	4.00	4.00	2.00	8.00

SOT-23 Tape Leader and Trailer

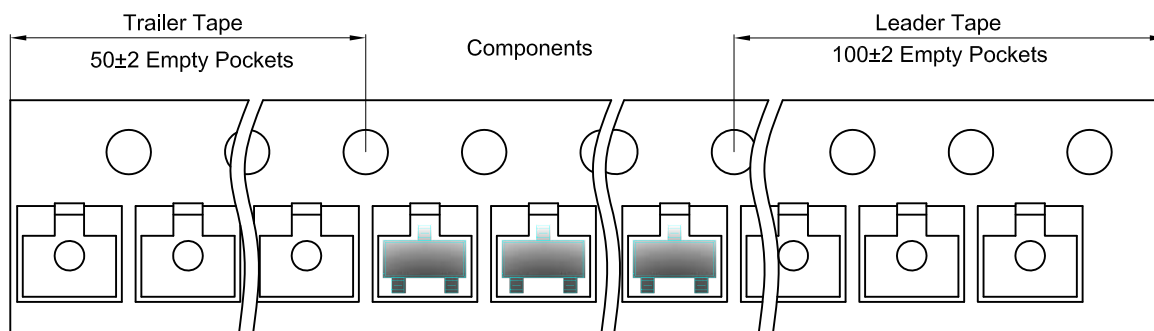

SOT-23 Reel

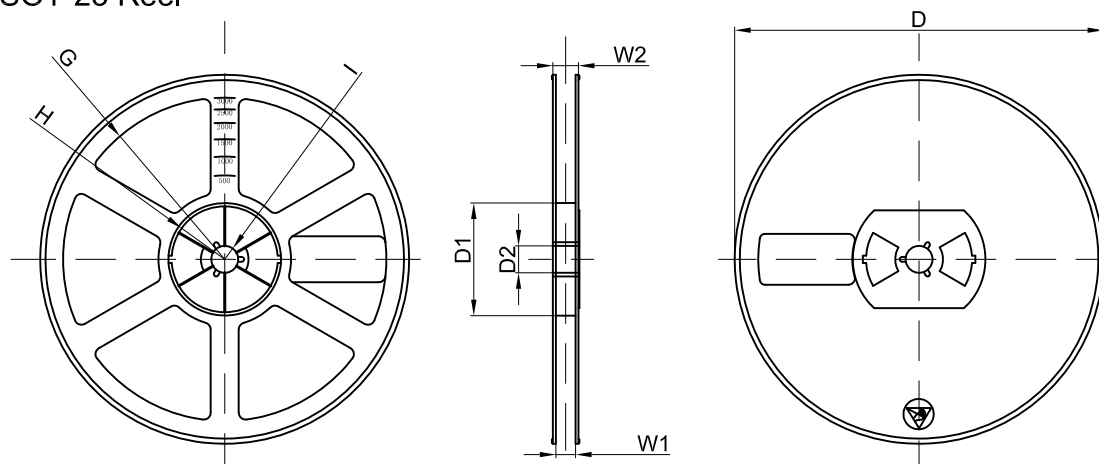

Dimensions are in millimeter								
Reel Option	D	D1	D2	G	H	I	W1	W2
7" Dia	Ø178.00	54.40	13.00	R78.00	R25.60	R6.50	9.50	12.30

REEL	Reel Size	Box	Box Size(mm)	Carton	Carton Size(mm)	G.W.(kg)
3000 pcs	7 inch	30,000 pcs	203×203×195	120,000 pcs	438×438×220	