

### Feature

- Glass Passivated Chip
- 400W Peak Pulse Power Capability With a 10/1000us Waveform
- Repetitive Rate (duty cycle): 0.01%
- Excellent Clamping Capability
- Low Reverse Leakage
- Very Fast Response Time
- Lead And Body According With Rohs Standard

### Mechanical Data

- Case: SMA/DO214AC Molded Plastic
- Lead: Solderable Per MIL-STD-750, Method 2026
- Epoxy: UL 94V-0 Rate Flame Retardant
- Polarity: Color Band Denotes Cathode End Except Bipolar
- Mounting Position: Any

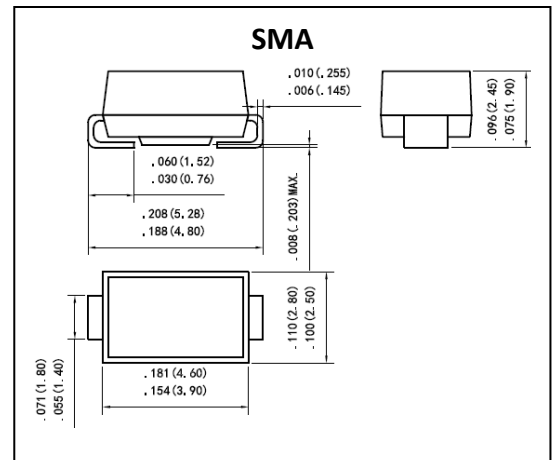

### Absolute Maximum Ratings ( $T_A=25^{\circ}\text{C}$ unless otherwise noted)

| Parameter   | Symbol    | Value      | Unit               |
|---|-----------|------------|--------------------|
| Peak Power Dissipation With a 10/1000 us Waveform <sup>1)</sup>                           | $P_{PP}$  | 400        | W                  |
| Peak Pulse Current With a 10/1000 us Waveform <sup>1)</sup>                               | $I_{PP}$  | 50         | A                  |
| Power Dissipation on Infinite Heatsink at $T_L = 75^{\circ}\text{C}$                      | $P_D$     | 1.0        | W                  |
| Peak Forward Surge Current, 8.3 ms Single Half Sinewave Unidirectional Only <sup>2)</sup> | $I_{FSM}$ | 40         | A                  |
| Maximum Instantaneous Forward Voltage at 25A For Unidirectional Only                      | $V_F$     | 3.5        | V                  |
| Junction Temperature  | $T_J$     | -55 ~ +150 | $^{\circ}\text{C}$ |
| Storage Temperature   | $T_{STG}$ | -55 ~ +150 | $^{\circ}\text{C}$ |

Note:

1: Non-repetitive current pulse per Fig.5 and derated above  $T_A = 25^{\circ}\text{C}$  per Fig.1;

2: Measured on 8.3 ms single half sine-wave or equivalent square wave, duty cycle = 4 pulses per minute maximum;

### Electrical Characteristics ( $T_A=25^{\circ}\text{C}$ unless otherwise specified)

| Part Number | Reverse Stand-off Voltage | Breakdown Voltage VBR (Volts) @ $I_T$ |     | Test Current | Maximum Clamping Voltage | Maximum Peak Pulse Current | Maximum Reverse Leakage      | Marking |
|-------------|---------------------------|---------------------------------------|-----|--------------|--------------------------|----------------------------|------------------------------|---------|
|             |                           | MIN                                   | MAX |              |                          |                            |                              |         |
| UNI         | $V_R$ (V)                 |                                       |     | $I_T$ (mA)   | $V_C @ I_{PP}$ (V)       | $I_{PP}$ (A)               | $IR @ V_R$ ( $\mu\text{A}$ ) | UNI     |
| SMAJ3.3A    | 3.3                       | 5.2                                   | 6.0 | 10           | 8                        | 50                         | 800                          | 3V3     |

**Typical Characteristics**

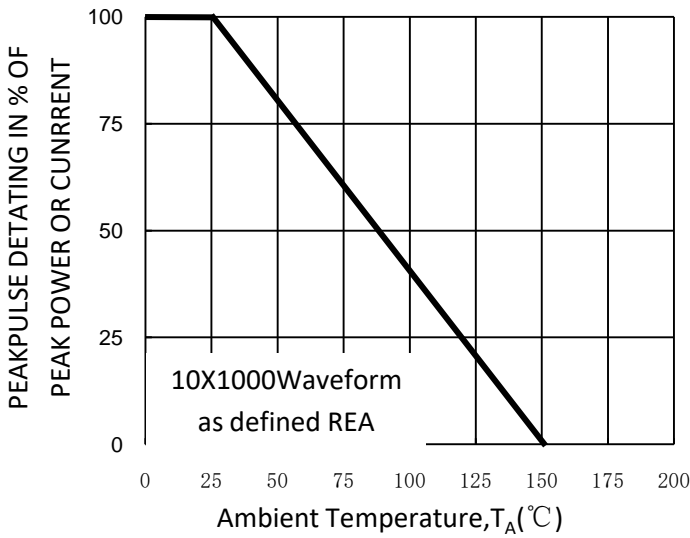

Fig. 1-Pulse Derating Curve

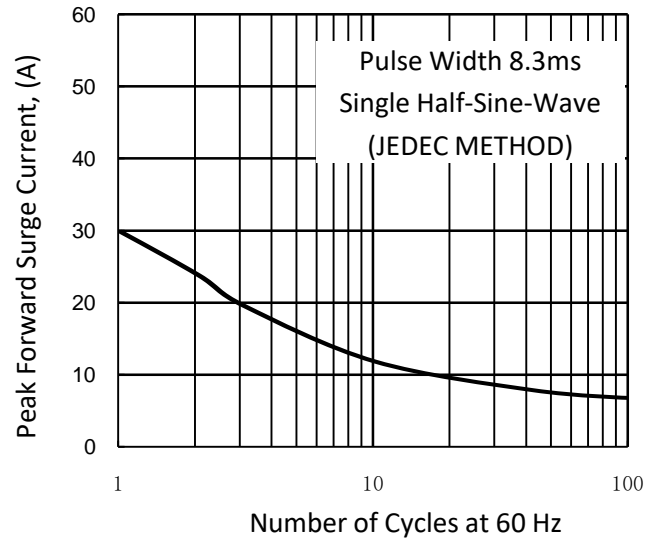

Fig. 2-Maximum Non-Repetitive Surge Current

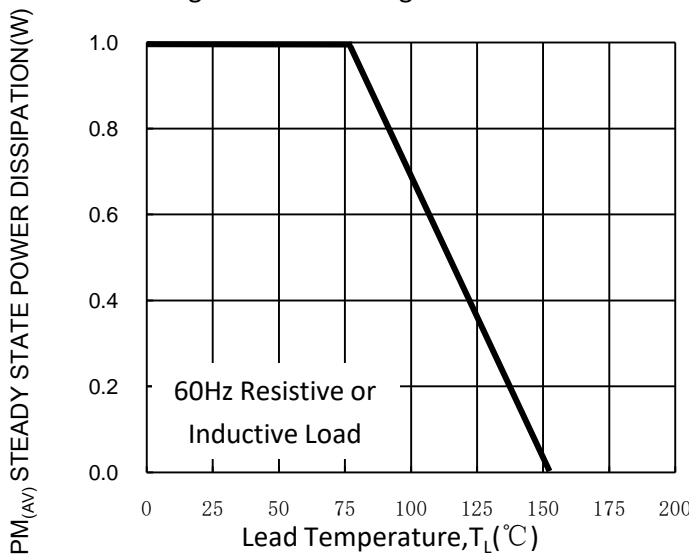

Fig. 3-Steady State Power Derating Curve

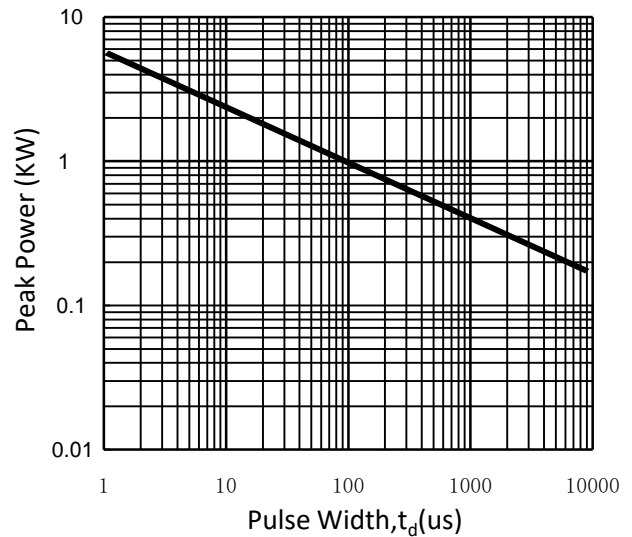

Fig. 4-Peak Pulse Power Rating Curve

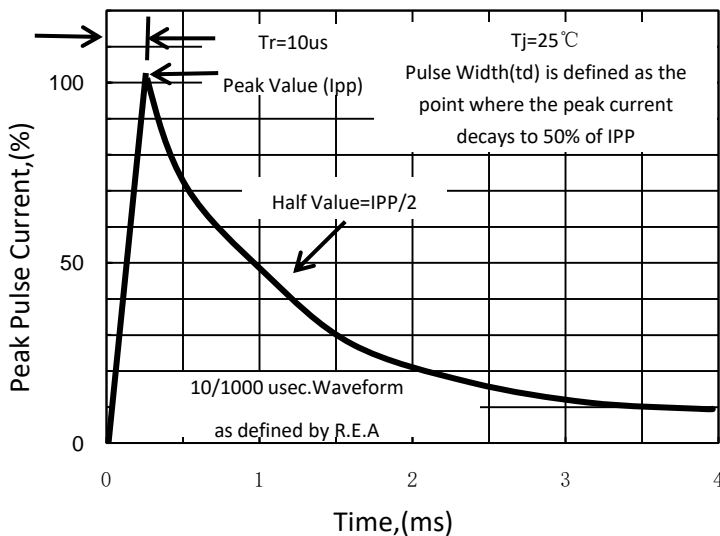

Fig. 5-Pulse Waveform

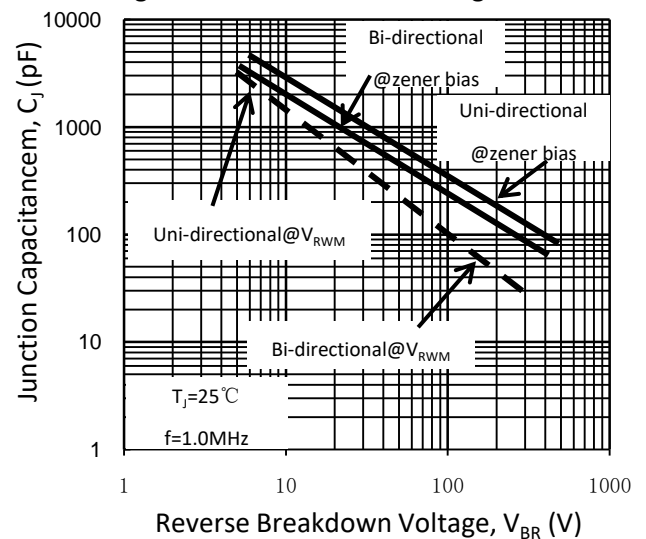

Fig. 6-Typical Junction Capacitance

**Attention:**

- GreenPower Electronics reserves the right to improve product design function and reliability without notice.
- Any and all semiconductor products have certain probability to fail or malfunction, which may result in personal injury, death or property damage. Customer are solely responsible for providing adequate safe measures when design their systems.
- GreenPower Electronics products belong to consumer electronics or other civilian electronic products.